

UWP 4.0

Universal web platform

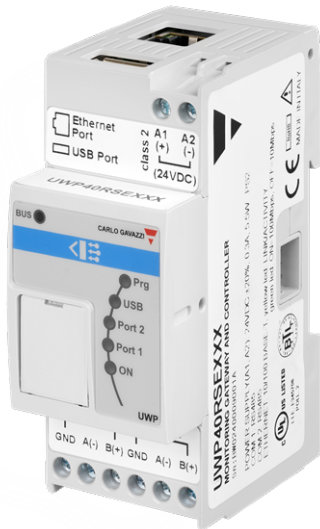

Description

UWP 4.0 is a monitoring gateway and controller that allows the monitoring and controlling of installations where Energy Efficiency Management and Building Automation functions are needed. The system monitors and controls connected devices via its local bus management functions; it includes a web server with a powerful and intuitive user interface to display customised dashboards and interact with local devices and remote systems; the UWP 4.0 embedded automation server allows data to be exchanged locally or remotely via standard Internet protocols. UWP 4.0 can manage the complete lighting control system based on DALI-2 actuators and it can operate as a BACnet/IP gateway.

Applications

UWP 4.0 is suitable for applications in Building Automation, Energy Efficiency Performance Management and all their combinations are suitable application for UWP 4.0. Its comprehensive set of functions, small dimensions and reliability are the key factors for depending on UWP 4.0 as the local monitoring/controlling unit in a wider distributed scenario.

Benefits

- **Flexibility.** UWP 4.0 is the core of a powerful system which includes a complete range of meters, sensors and actuators
- **Integration.** UWP 4.0 includes all the necessary software tools to set up and operate the required solution. No subscriptions or additional services are required.
- **Interoperability.** By leveraging its automation-server functions, it is easy to exchange data with other systems via FTP, SFTP, FTPS, SMTP, Rest-API, MQTT, Modbus and BACnet.
- **Scalability.** It is easy to scale up the system, by leveraging its comprehensive set of monitoring, controlling and communication functions
- **Fast installation and set up.** Each function can be programmed with ease by means of the free configuration tool
- **Reliability.** The system is secure against cyber-attacks and computer viruses. It is the ideal Edge unit for providing local control and data redundancy to distributed applications, and for logging history and events.
- **IoT Ready.** UWP 4.0 is Microsoft Azure Certified for IoT
- **Powered by AWS.** UWP 4.0 is compatible with Amazon AWS IoT.
- **Awareness.** By means of scheduled reports and email/SMS alerts, users are constantly advised about installation status
- **Compact Size.** All of the above is available in a 2 DIN module
- **Powered by MAIA Cloud:** secure and reliable system for remotely managing, setting and operating UWP 4.0 units Worldwide.
- **IoT Security Rating:** Security Capabilities Verified by UL to Level SILVER for UWP 4.0 SE (*Security Enhancement*).
- **Optimised user interface.** Improved user experience for fast commissioning and easy daily operation.

Main functions

- Acting as a gateway for sharing data and receiving remote commands via BACnet, Modbus TCP/IP and Rest-API
- Monitoring energy control systems so as to check energy efficiency status and improvements.
- Recording, displaying and transmitting information (events and history)
- Defining logical functions, reacting to abnormal conditions and control actuators
- Setting up and operating Building Automation functions
- Setting up and operating Lighting Control functions and DALI-2

Main features

- Up to 5000 managed signals (including variables, I/Os) shared among Energy Management and Building Automation applications.
- Up to 128 Modbus devices connected to RS485 ports (64 devices each port).
- Up to 5 users concurrently connected to the Web-App.
- Up to 5 concurrent M2M connections (API connections, BACnet clients, Modbus masters).
- Up to 150 different products from the Carlo Gavazzi range can be connected to UWP 4.0
- BTL certified (max 1000 BACnet points for used BACnet objects).

Architecture and functions

Fieldbus level

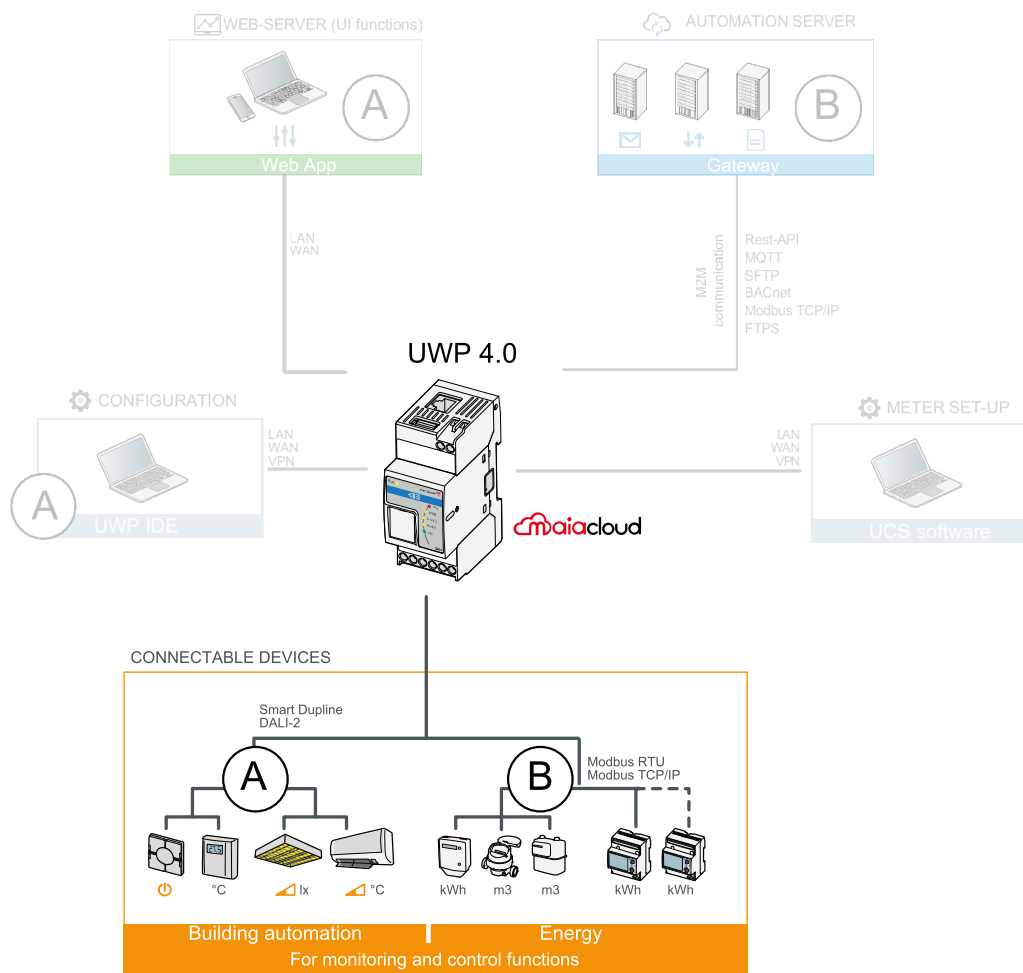

Element	Description	
A	Building automation	<ul style="list-style-type: none"> • Smart Dupline sensors and actuators • DALI devices
B	Energy monitoring	<ul style="list-style-type: none"> • Carlo Gavazzi Meters • Modbus RTU, Modbus TCP/IP slaves (any Modbus slave can be integrated thanks to the Free Modbus Editor tool)

Configuration and control functions

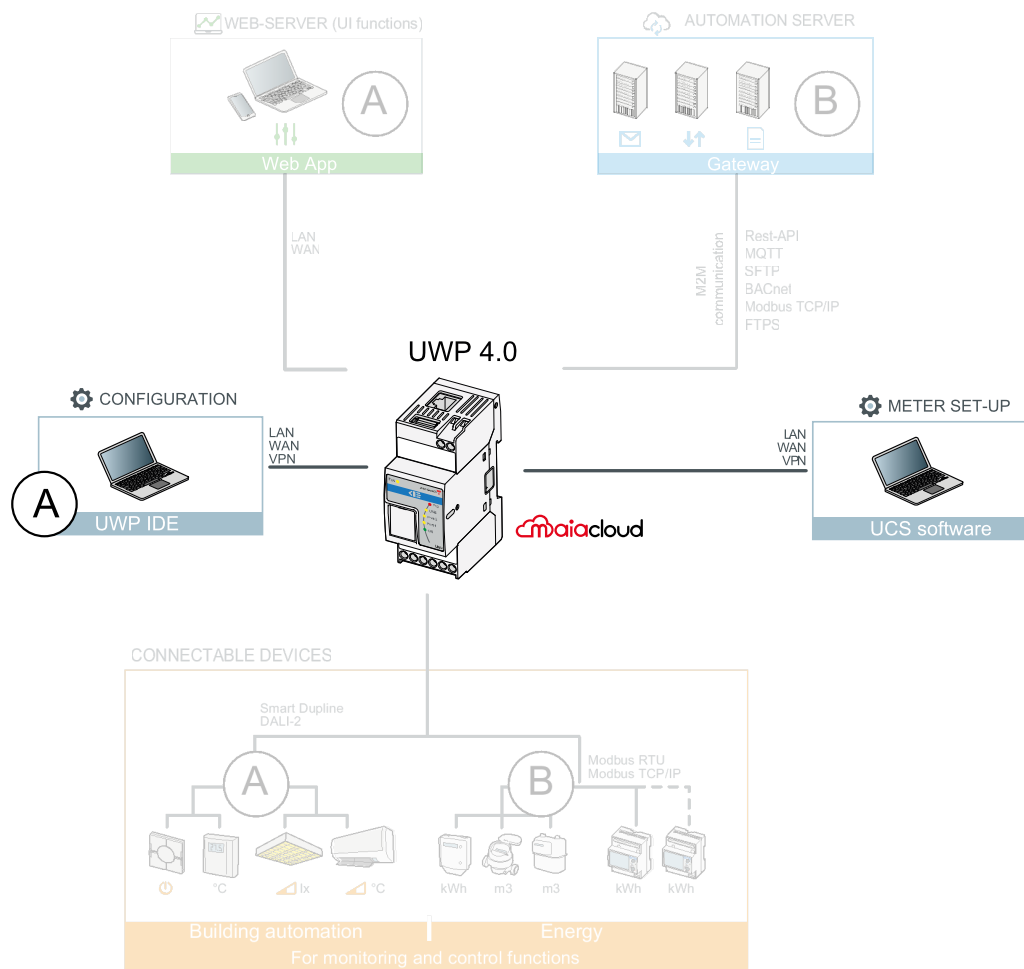

Element	Description	
A	Light control	<ul style="list-style-type: none"> • ON/OFF switching • Standard Light Control functions (including DALI-2* and dimming) and advanced Light Control, including Tunable White Control and Constant Light • *DALI-2 certified control
	Blinds and motor	<ul style="list-style-type: none"> • Roller blind control • Gate control • Valve control
	Temperatures control	<ul style="list-style-type: none"> • System and zone temperature functions • Vehicle heating
	Sequence and calendar	<ul style="list-style-type: none"> • Sequence • Calendar • Smart calendar

Element	Description	
A	Alarms	<ul style="list-style-type: none"> • Generic supporting ISA standards • Smoke • Water • Zone • Intruder • Counter alarm (including batch counter)
	Others	<ul style="list-style-type: none"> • Timers • Switch • Analogue comparator • Multigate • Mathematical • Analogue outputs • Counter • Astronomical clock
	BEMS* integration	<ul style="list-style-type: none"> • Commands over Modbus • BMS integration via Modbus TCP/IP and BACnet • Modbus driver writing/reading functions for any Modbus device

*Building Energy Management System.

User interface and automation server functions

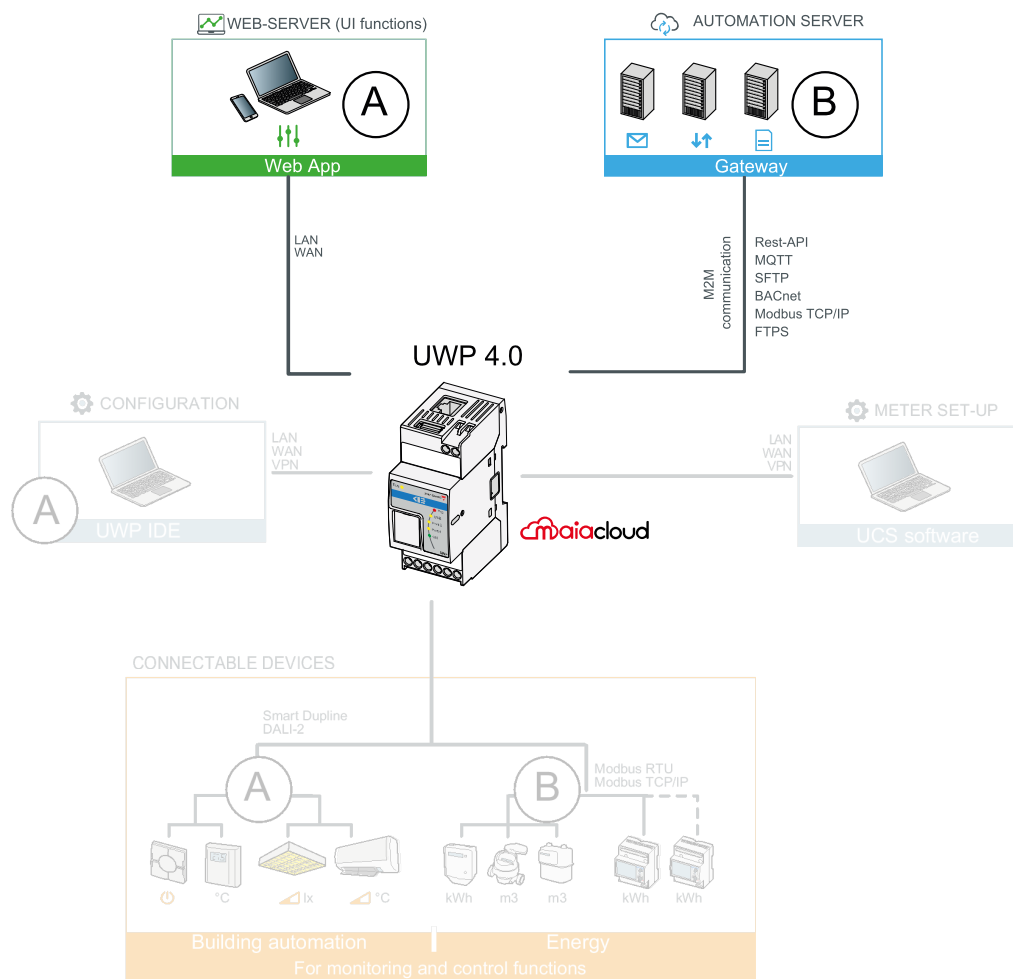

Element	Description
A	<ul style="list-style-type: none"> • Customised dashboards • Charting tools for displaying and analysing history data • Cost centres base navigation tree • Energy Summary display • Dedicated widgets for monitoring control functions
B	<ul style="list-style-type: none"> • M2M communication via: Rest-API, FTP, SFTP, FTPS, MQTT, SMTP, Modbus TCP/IP, BACnet • Automation gateway: Rest-API, Modbus TCP/IP, BACnet • Email or SMS alerts • Multi-site data aggregation via Em²-Server • Microsoft Azure certified for IoT • Powered by Amazon AWS IoT.

Structure

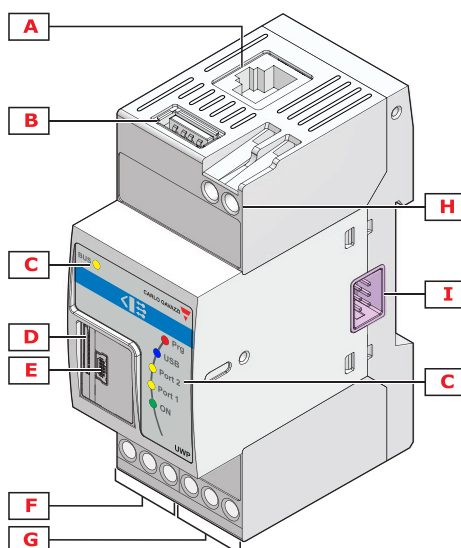

Area	Description
A	Ethernet port
B	USB port (Host function)
C	<p>Indicator LEDs:</p> <p>Green (ON) ON - Power ON OFF - Power OFF</p> <p>Yellow (BUS) ON - Communication OK for all the MCGs connected to the HS-bus OFF - No communication is present on the HS-bus Flashing - Communication errors for some of the MCGs connected to the HS-bus</p> <p>Yellow (Port 1) OFF - Communication disabled Flashing 200 ms ON, 600 ms OFF - No communications on RS485 COM1 Flashing 200 ms ON, 200 ms OFF - Communications OK</p>

Area	Description
C	Indicator LEDs:
	Yellow (Port 2) OFF - Communication disabled Flashing 200 ms ON, 600 ms OFF - No communications on RS485 COM2 Flashing 200 ms ON, 200 ms OFF - Communications OK
	Blue (USB) ON - USB/SD device is present OFF - No USB/SD device is present Flashing - Backup in progress
	Red (Prg) ON - UWP is connected to the UWP IDE OFF - UWP is disconnected from the UWP IDE Flashing - Loading/activating configuration
D	Micro SD memory card slot
E	Micro-USB port (Device function)
F	RS485 COM1 port terminals
G	RS485 COM2 port terminals
H	Power supply connection block
I	Local bus ports (left side and right side)

Features

General

Material	Noryl, self-extinguishing V-0 (UL94)
Dimensions	2-DIN module
Weight	150 g
Protection degree	Front: IP40; Screw terminals: IP20
Dielectric strength	4000 V AC RMS for 1 minute
Rejection (CMRR)	65 dB, from 45 to 65 Hz
Terminals	8 terminals, screw-type; Section: 1.5 mm ² maximum; Torque: from 0.4 to 0.8 Nm

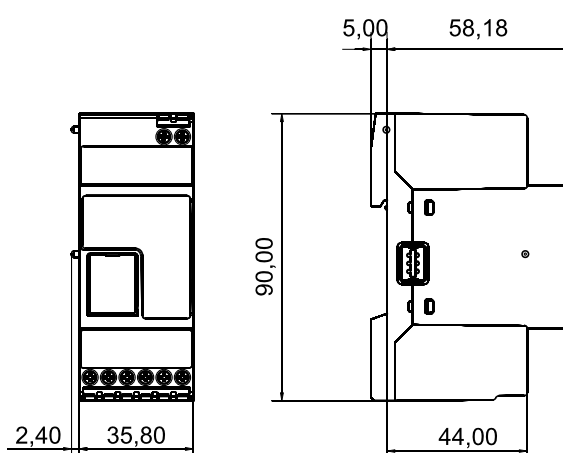

Environmental

Operating temperature	-20° to +50 °C (-4 ° to 122 °F)
Storage temperature	-30° to +70 °C (-22 ° to +158 °F)
Humidity (non-condensing)	20 to 90% RH

Power Supply

Power Supply	15-28 V DC
Consumption	≤ 5 W
Battery	1 Metal-ion non-replaceable battery; 0.04 g

Note: The device contains metal-ion batteries. For the sending, you must comply with the relevant packaging and labelling regulation.

Inputs/outputs insulation

Type of input/output	DC power supply	RS485 COM1	RS485 COM2	Ethernet	USB port "H"	USB port "D"	Local bus ports
DC power supply	-	0.5 kV	0.5 kV	0.5 kV	0 kV	0 kV	0 kV
RS485 COM1	0.5 kV	-	0.5 kV	0.5 kV	0.5 kV	0.5 kV	0.5 kV
RS485 COM2	0.5 kV	0.5 kV	-	0.5 kV	0.5 kV	0.5 kV	0.5 kV
Ethernet	0.5 kV	0.5 kV	0.5 kV	-	0.5 kV	0.5 kV	0.5 kV
USB port "H"	0 kV	0.5 kV	0.5 kV	0.5 kV	-	0 kV	0 kV
USB port "D"	0 kV	0.5 kV	0.5 kV	0.5 kV	0 kV	-	0 kV
Local bus ports	0 kV	0.5 kV	0.5 kV	0.5 kV	0 kV	0 kV	-

- 0 kV: inputs / outputs are not insulated.
- 2 kVrms: EN61010-1, IEC60664-1 - over-voltage category III, pollution degree 2, double insulation on systems with max. 300 Vrms to ground.
- 0.5 kVrms: the insulation is functional type Mounting.

Compatibility and conformity

Standards	Electromagnetic compatibility (EMC) - immunity: EN61000-6-2
	Electromagnetic compatibility (EMC) - emissions: EN61000-6-3
	Safety: EN62368-1
Directives	EMC 2014/30/EU
	LVD 2014/35/EU
	RoHS 2011/65/EU

Approvals



Cybersecurity Rating (SE version)

Ports

Ethernet

Standard	ISO9847
LAN configuration	Static or DHCP IP Address; Net Mask; Default Gateway, DNS (primary, secondary)
Protocols	HTTP, HTTPS, FTP, FTPS, SFTP, Modbus TCP/IP, DP (Data Push), SMTP, NTP, Azure IoT Hub, Modbus Gateway TCP/RTU, BACnet IP, Rest-API
Client connections	WEB server: Port: 443 (by default*); 5 connections <i>*Note: you can activate port 80.</i> IDE: 1 connection Modbus TCP/IP: 5 connections
Connection type	RJ45 connector (10 Base-T, 100 Base-TX); maximum distance: 100 m

RS485

Number of ports	2
Function	COM1: Master or slave (gateway function) COM2: Master
Number of slaves	COM1: up to 64 COM2: up to 64
Connections	2-wire. Max. distance 600 m
Protocol	Modbus RTU
Data format	Selectable: 1 start bit, 7/8 data bit, no/odd/even/ parity, 1/2 stop bit
Baud rate	Selectable: from 110 to 256000 bits/s

USB

Type	Hi-speed 2.0 Type-A
Mode	Host
Communication speed	60 MB/s
Function	Backup for disaster recovery

Supported devices	USB mass storage: direct connection to UWP 4.0 USB modem/router can be directly connected
Supported File System	ext4, NTFS, FAT32

Micro USB

Type	High-speed USB 2.0 Micro-B
Mode	Device
Speed	60 MB/s
Function	RNDIS (Virtual Ethernet) Network Access via IP: 192.168.254.254

To download the virtual Ethernet network card driver, go to:
https://gavazziautomation.com/images/PIM/BROCHURE/ENG/mini-USB_driver.zip

Micro SD slot

Type	Industrial (from -25 to +85 °C / -13 to + 185 °F)
Capacity	SD and SDHC Up to 32 GB
Function	Backup for disaster recovery
Supported File System	ext4, NTFS, FAT32

HS bus

Bus type	RS485 high speed bus
Function	Connection to master channel generator modules (SH2MCG24, SH2WBU230x and SH2DUG24)
Number of slaves	Maximum 7
Connection	By local bus on the right hand side <i>Note: All the SH2MCG24, SH2WBU230x and SH2DUG24 modules have to be connected on the right hand side of the UWP 4.0.</i>
Termination	Always required on the last module
Max distance	600 m

TCP/IP ports

Inbound communication

Port number	Description	Purpose
80*	HTTP	Access to the internal web-server, API functions
443*	HTTPS	Access to the internal web-server, API functions
52325	SSH	Remote service (reserved to support personnel)
10000	UWP 4.0	Configuration and maintenance (UWP IDE)
10002	UWP 4.0	Configuration and maintenance (UWP IDE)
52326	UWP 4.0	Firmware and configuration update (UWP IDE)

*Note: port 443 is the default one but you can also activate port 80.

Outbound communication

Port number	Description	Purpose
53	DNS	Domain name resolution
123	NTP	Network time services access
21*	FTP	Data upload to FTP server
25*	SMTP	Email message dispatching
80	HTTP	DP (data push communication)

*Note: these ports are the default ones but users can change them.

UCS bridge

Mode	Port	Description
Secure	443	For the HTTPS connection for bridge opening.
Insecure	503	Through any TCP Modbus client. <i>Note: this port is the default one. Users can change it from the Web-App relevant page.</i>
	41214	Default port (to be enabled) for Modbus bridge. <i>Note: this port is the default one but users can change it.</i>

Modbus TCP/IP

Function	TCP/IP port	Purpose
Modbus TCP/IP Slave	502 (selectable)	Modbus TCP data communication
Modbus bridge TCP/RTU	503 (selectable)	Bridge function for accessing (read and write) RTU meter connected to the UWP RTU ports

MAIA Cloud ports

Inbound communication (Through the tunnel)

Port number	Description	Purpose
80*	HTTP	Access to the internal web-server, API functions
443*	HTTPS	Access to the internal web-server, API functions
52325	SSH	Remote service (reserved to support personnel)
10000	UWP 4.0	Configuration and maintenance (UWP IDE)
10002	UWP 4.0	Configuration and maintenance (UWP IDE)
52326	UWP 4.0	Firmware and configuration update (UWP IDE)

*Note: port 443 is the default one but you can also activate port 80.

Outbound communication (Through the tunnel)

Port number	Description	Purpose
53	DNS	Domain name resolution
123	NTP	Network time services access
21*	FTP	Data upload to FTP server
25*	SMTP	Email message dispatching
80	HTTP	DP (data push communication)

*Note: these ports are the default ones but users can change them.

UCS bridge

Mode	Port	Description
Secure	443	For the HTTPS connection for bridge opening.
Insecure	503	Through any TCP Modbus client. <i>Note: this port is the default one. Users can change it from the Web-App relevant page.</i>
	41214	Default port (to be enabled) for Modbus bridge. <i>Note: this port is the default one but users can change it.</i>

 For tunnelling

Access	Ports
MAIA Cloud Web	443/tcp and 1194/udp
MAIA Cloud App software	443/tcp and 1194/udp

Note: through the tunnelling service, all the above-mentioned ports are supported.

Data management

Multi-BUS communication	INPUT from: Modbus RTU, Modbus TCP/IP, Dupline OUTPUT to: Modbus RTU, Modbus TCP/IP, BACnet, Dupline, DALI-2
Embedded Database	Embedded database for storing system configuration, variables, events Flexible data model based on signals definition and functions creation
Automation server	Automation server for exchanging data with other systems via: FTP, SFTP, FTPS, Rest-API, SMTP, MQTT

**Note: Data stored on the internal UWP 4.0 database (including logged data points, events and configuration parameters) are preserved in the case of system shut-down. UWP 4.0 storage memory size is 4.0 GB (including all the logged data points, events and configuration parameters).*

Software and interfaces

MAIA Cloud

Remote access is the key to minimize the Total Cost Of Ownership of an UWP 4.0 powered installation; by leveraging the networking capabilities of MAIA Cloud, it is possible to take control of remote installations without leaving your office.

Benefits

- Reduced costs. Thanks to the VPN safe remote access, users do not need to travel and consequently waste money and time to solve their customers' issues.
- Easy automatic remote networking
- Hassle free regardless of destination and IP address.

Main functions

- Authentication: MAIA Cloud users can remotely access their UWP 4.0 fleets and manage them if needed.
- Security. Remote connections to MAIA Cloud and to the remote UWP 4.0 Edge units thanks to encrypted tunnelling.
- Hassle-free. Thanks to the MAIA Cloud tunnelling functions, you do not need to worry about IP address changes and firewalls. You could always access your device, according to your security policies.
- Remote set-up and operation. Thanks to MAIA Cloud, it is possible now to remotely:

- Set-up of any Modbus/RTU CG Meter (via UCS)

- Set-up of any Modbus/TCP CG meter (via UCS)

- Set-up of any Smart Dupline item (via UWP IDE)

- Establishment of a VPN connection to your PC

- Surfing on the UWP 4.0 web-interface.

Architecture

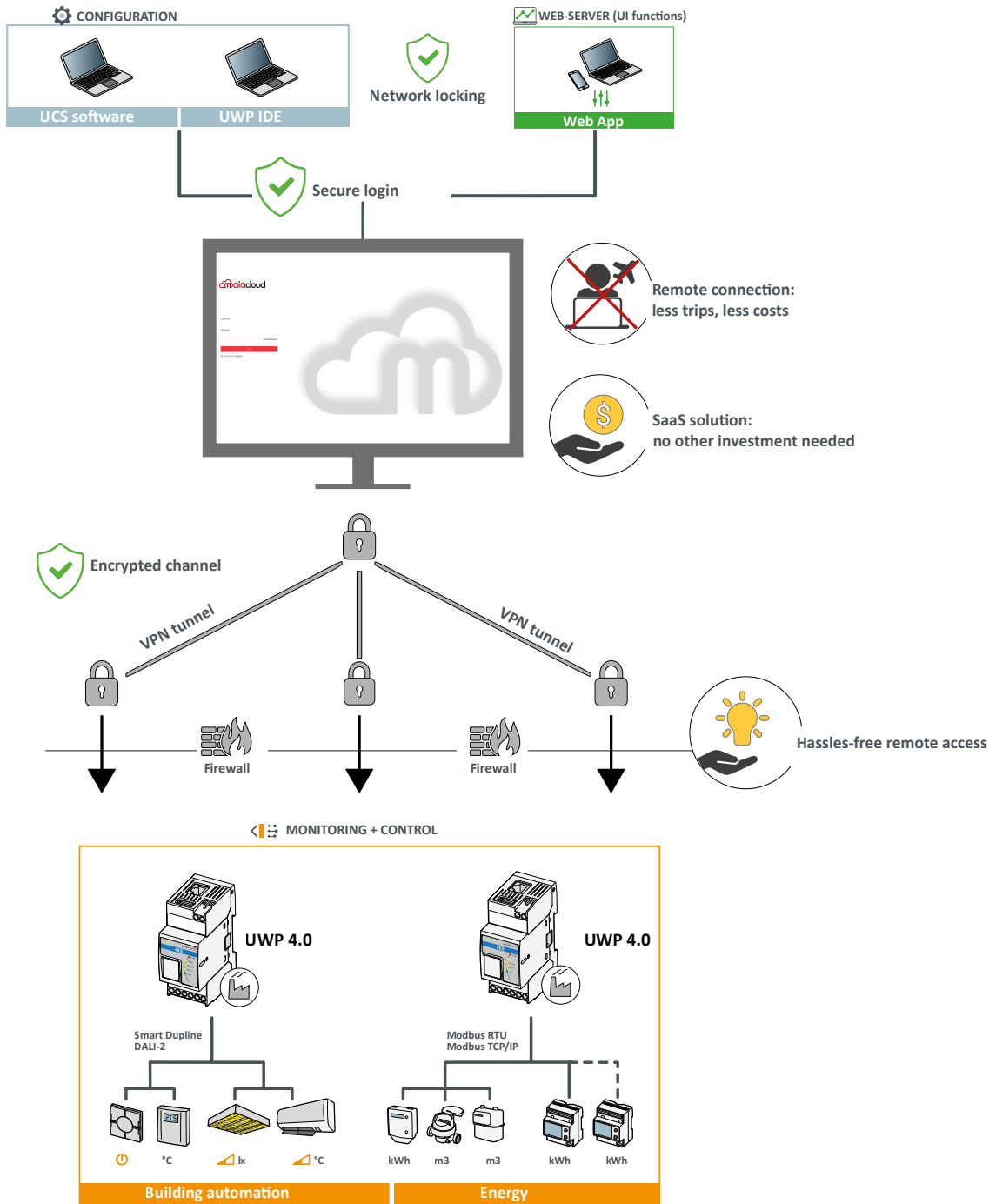

UWP IDE

UWP IDE is the UWP 4.0 configuration software. It allows the user to:

- carry out the system commissioning
- define the automation and control logics
- set the measuring instruments and sensors monitoring.

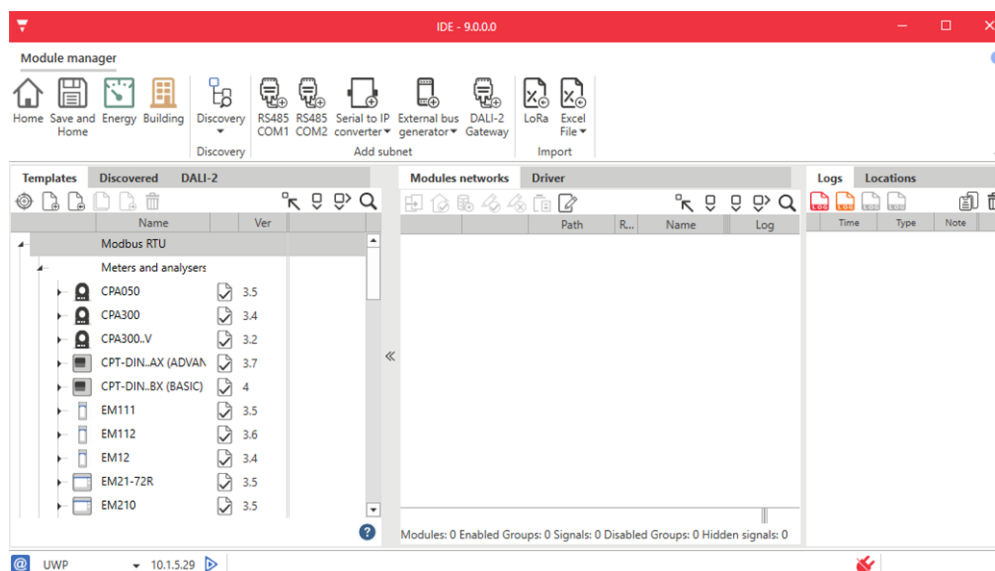

Main functions

- Execute the Dupline modules automatic scan for fast commissioning
- Configure interfaces and communication protocols
- Configure and manage the connected modules
- Define the control and automation functions
- Generate a driver to monitor third party Modbus devices
- Set the data and events collection and storage from Carlo Gavazzi or third party instruments
- Develop Modbus drivers for UWP 4.0 with both reading and writing functions for any Modbus device
- Save a configuration offline for backup or any subsequent use

UWP 4.0 Web App

The UWP 4.0 Web App is the UWP 4.0 Web Interface, accessible through Web browsers from mobile or desktop devices. Through widgets contained in predefined and customised dashboards, it allows the user to:

- view and export collected data
- control the automation functions
- define specific settings (User Interface and Server Automation).

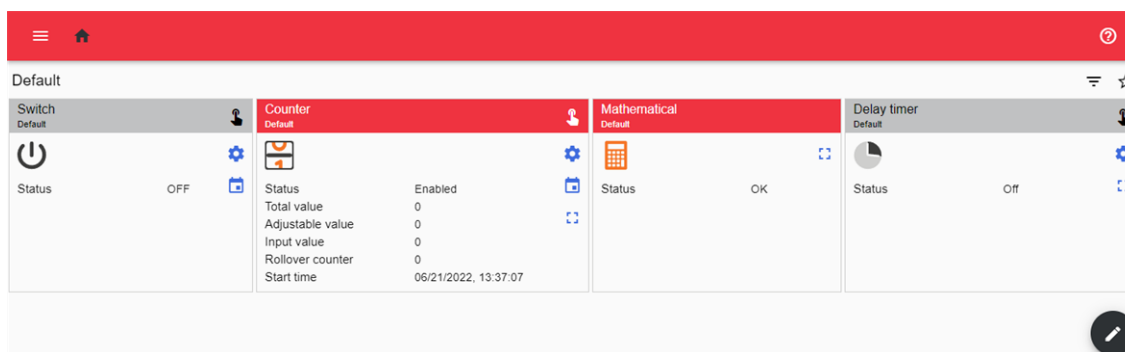

Main functions

- View collected data as real time values or charts
- Generate data and events reports
- Manage and adjust the functions parameters (e.g. modify temperature set points)
- Send commands (e.g. switching on/off or select scenarios)
- Configure Data Push Services to FTP/SFTP/FTPS servers or Em2-Server (Carlo Gavazzi)
- Configure MQTT link to IoT Hubs (Amazon AWS and Microsoft Azure)

Cybersecurity

Introduction

Cybersecurity is the practice of protecting systems, networks, and programs from digital attacks. These cyberattacks are usually aimed at:

- accessing, changing, or destroying sensitive information;
- extorting money from users;
- interrupting normal business processes.

Implementing effective cybersecurity measures is particularly challenging today because there are more devices than people, and attackers are becoming more innovative.

For UWP 4.0 SE (Security Enhanced), the security capabilities have been verified by UL to Level SILVER.

The SILVER rating certifies the enhanced security capabilities of UWP 4.0 SE regarding:

- Access Control
- Industry Privacy Best Practices
- Product Security Maintenance.



Pillars

- Disaster recovery. UWP 4.0 includes a solid disaster recovery system for saving and restore both configuration and history data on USB stick, SD card, SFTP server.
- Easy upgrade function. UWP IDE and web app notify users about the availability of a new software and firmware version; the whole upgrade process is managed by the UWP IDE.
- UWP secure bridge function. It permits you to establish a secure connection through LAN or Internet network between the UCS software and Carlo Gavazzi Modbus meters connected to UWP 4.0 via RS485 or LAN network. This way, you can perform the following tasks remotely:
 - configure a wired device via UCS without disconnecting UWP 4.0;
 - check the proper functioning of the devices, the real time measures, the status of alarms and the inputs/outputs

- modify or correct the configuration parameters, in case of measures anomalies or of project structure changes.

- Secure access: thanks to MAIA Cloud, you can access a UWP 4.0 system through a secure VPN (virtual private network).
- Minimalist approach: UWP 4.0 has been designed to include only the necessary sub-systems into a highly optimized linux core, so to avoid unnecessary risks due to attacks to unmonitored services.

For further information, refer to the following guideline: “Security in energy monitoring and building automation applications based on the UWP 4.0 ecosystem”.

Connection diagrams

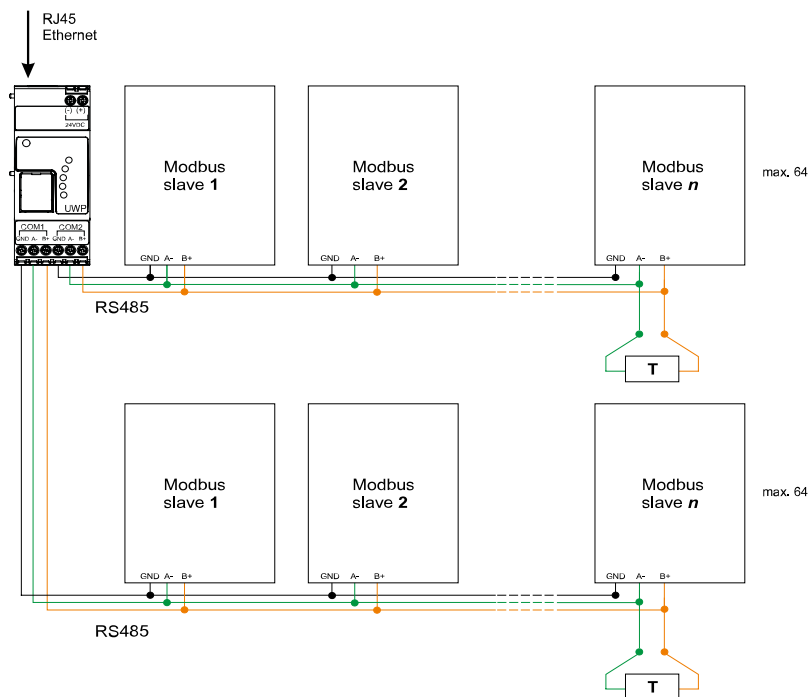

Fig. 1 Modbus RTU connection. COM 1 master, COM 2 master

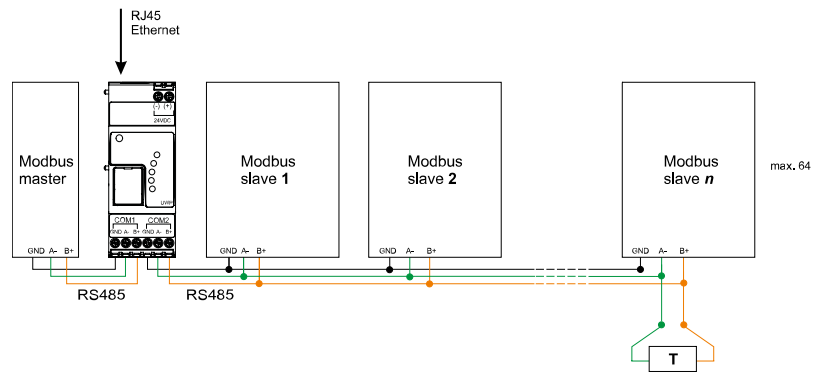

Fig. 2 Modbus RTU connection. COM 1 slave, COM 2 master

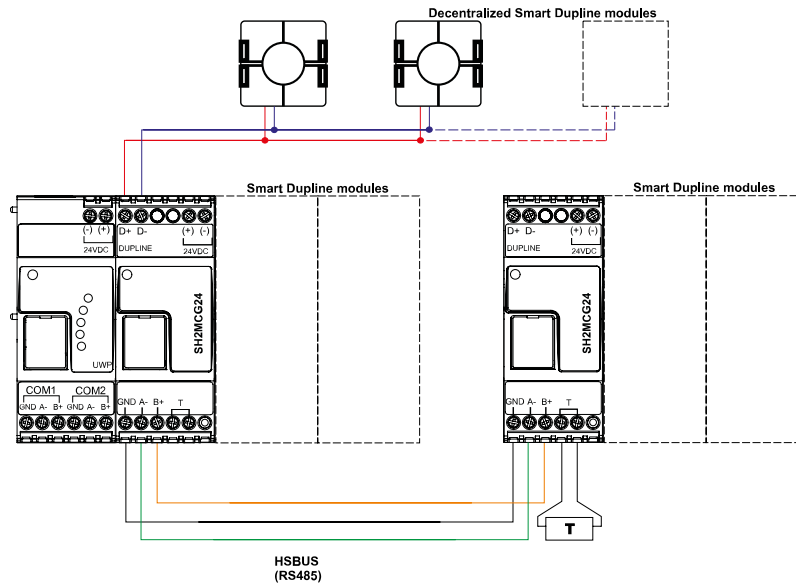

Fig. 3 Example of Smart Dupline modules connection using master channel generators

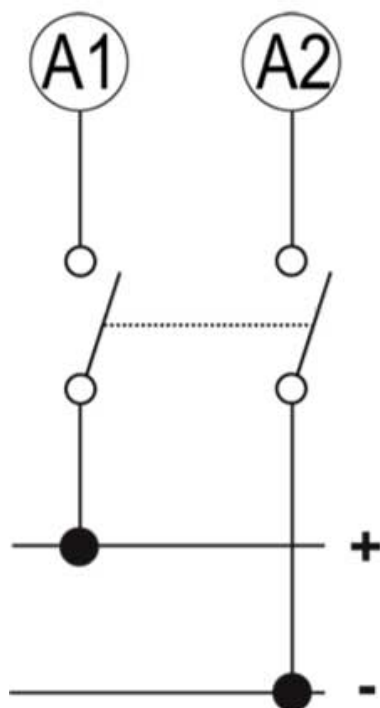

Fig. 4 Power Supply

References

Compatible devices

Device	Instruction manual
UWP-MODEM-KIT-4G-E02	www.gavazziautomation.com/UWP-Modem-Kit-4G-E02.pdf
UWP-ROUT-KIT-EU	www.gavazziautomation.com/UWP-ROUT-KIT-EU_A3.pdf
UWP-ROUT-KIT-US	www.gavazziautomation.com/UWP-ROUT-KIT-US_A3.pdf

Further information

Document	Where to find it
UWP IDE manual	www.gavazziautomation.com/UWPIDE_ENG.pdf
UWP 4.0 Web App - Instruction manual	www.gavazziautomation.com/UWPWebApp_ENG.pdf
MAIA Cloud system user manual	www.gavazziautomation.com/MAIA_Cloud_EIM.pdf

MAIA Cloud licences

Information	Description	Document
UWP-LICENCE-M01B	MAIA PLUS LICENCE-12 MONTHS VPN	MAIA Licence A4 pdf Licence Code EIM pdf
UWP-LICENCE-M02A	MAIA STANDARD LICENCE-2 DEVICES	
UWP-LICENCE-M02B	MAIA PLUS LICENCE-24 MONTHS VPN	
UWP-LICENCE-M04B	MAIA PLUS LICENCE-48 MONTHS VPN	
UWP-LICENCE-M05B	MAIA PLUS LICENCE-60 MONTHS VPN	
UWP-LICENCE-M10A	MAIA STANDARD LICENCE-10 DEVICES	
UWP-LICENCE-M25B	MAIA PLUS LICENCE-300 MONTHS VPN	
UWP-LICENCE-M50A	MAIA STANDARD LICENCE-50 DEVICES	
UWP-ACTIVATION-KEY	MAIA ACTIVATION LICENCE	MAIA Activation A4 pdf Activation Key EIM pdf

How to order

Component code	Description
UWP40RSEXXX	Monitoring gateway and controller
UWP40RSEXXXSE	Monitoring gateway and controller security enhanced



COPYRIGHT ©2023

Content subject to change. Download the updated version:

www.gavazziautomation.com