

Ultrasonic Diffuse, Digital Output Types UA30EAD.....TI

CARLO GAVAZZI



- Cylindrical M30 Stainless Steel INOX AISI 316L housing
- Sensing distance: 350-3500 mm
- Power supply: 12 to 30 VDC
- Outputs: Two multi function switching outputs. PNP or NPN
- Setup: Normal switching or adjustable hysteresis
- Repeatability 1%
- Beam angle. $\pm 7^\circ$
- Protection: Short-circuit, reverse polarity and overvoltage
- Protection degree IP 67
- 2 m cable or M12 plug



Product Description

A self-contained multi function diffuse ultrasonic sensor in Stainless steel housing and with a sensing range of 350 to 3500 mm. 2 switching outputs - easily set up for two different output modes and adjusted by teach-in - makes it ideal for level control tasks in a wide variety of vessels.

A sturdy one-piece Stainless steel housing provides the perfect packaging for the sophisticated microprocessor controlled and digitally filtered sensor electronics. Excellent EMC performance and precision are typical features of this sensor on true distance measurement.

Ordering Key

UA30EAD35NPM1TI

Ultrasonic sensor	_____
Housing style	_____
Housing size	_____
Housing material	_____
Housing length	_____
Detection principle	_____
Sensing distance	_____
Output type	_____
Output configuration	_____
Connection	_____
Teach-in	_____

Type Selection

Housing diameter	Connection	Rated operating dist. (S _n)	Digital output NPN/PNP	Ordering no.
M30	Plug M12	350-3500 mm	2 x NPN	UA 30 EAD 35 NP M1 TI
M30	Cable	350-3500 mm	2 x NPN	UA 30 EAD 35 NP TI
M30	Plug M12	350-3500 mm	2 x PNP	UA 30 EAD 35 PP M1 TI
M30	Cable	350-3500 mm	2 x PNP	UA 30 EAD 35 PP TI

Specifications

Rated operating distance (S_n)	Reference target: 1 mm metal rolled finish, size 400 x 400 mm. 350 - 3500 mm	Output current continuous (I_e) Max. load capacity 100 nF UL508 specification	≤ 300 mA ≤ 100 mA
Blind zone	≤ 350 mm	Output current short-time (I) Max. load capacity 100 nF UL508 specification	≤ 300 mA ≤ 100 mA
Repeatability	1%	Minimum operational current (I_m)	≤ 0.5 mA
Beam angle	±7°	OFF-state current (I_o)	≤ 10 μA
Adjustment Push-button	P1 (farthest setpoint) P2 (nearest setpoint)	Voltage drop (U_d)	≤ 2.2 VDC @ 100 mA
Temperature drift	≤ 0.1%/°C @ -20° to +70° C	Protection	Short-circuit, overvoltage and reverse polarity
Temperature compensation	Yes	Carrier frequency	112 kHz
Hysteresis (H)	Min. 1%	Operating frequency (f)	≤ 2 Hz
Rated operational voltage (U_B)	12 to 30 VDC (ripple included)	Response time OFF-ON (t_{ON})	≤ 250 mS
Ripple (U_{ripple})	≤ 5%	Response time ON-OFF (t_{OFF})	≤ 250 mS
No-load supply current (I_s)	≤ 50 mA @ U _B max	Power ON delay	≤ 1500 mS

Specifications (cont.)

Output function, open collector By sensor type	NPN or PNP	Shock	30 g / 11 mS, 3 directions (IEC/EN 60068-2-27)
Output switching function	Two open collector transistor outputs to be configured as: - Normal Switching function with N.O and N.C. output. - Adjustable hysteresis Filling or emptying control	Rated insulation voltage	< 500 VAC (rms)
Indication Output ON Echo received	Yellow LED Green LED	Housing Material body Material front Material back, plug Material back, cable Material push-button Sealing around push-button Material sealing front	AISI 316L Epoxy-glass resin Grilamid Grilamid TPE TPE TPE
Environment Installation category Pollution degree Degree of protection	III (IEC 60664/60664A; 60947-1) 3 (IEC 60664/60664A; 60947-1) IP67 (IEC 60529; 60947-1) Nema 4X	Connection Cable Plug	PVC, grey, 2 m, 4 x 0.34 mm ² , Ø = 4.7 mm M12, 4-pin (CON. 14-series)
Ambient temperature Operating Storage	-20° to +70°C (-4° to +158°F) -35° to +70°C (-31° to +158°F)	Tightening torque	≤ 100 Nm
Vibration	10 to 55 Hz, 1.0 mm/6G. (IEC/EN 60068-2-6)	Weight Cable version Plug version	220 g 150 g
		CE-marking	Yes
		Approvals	cULus (UL508)

Wiring Diagram

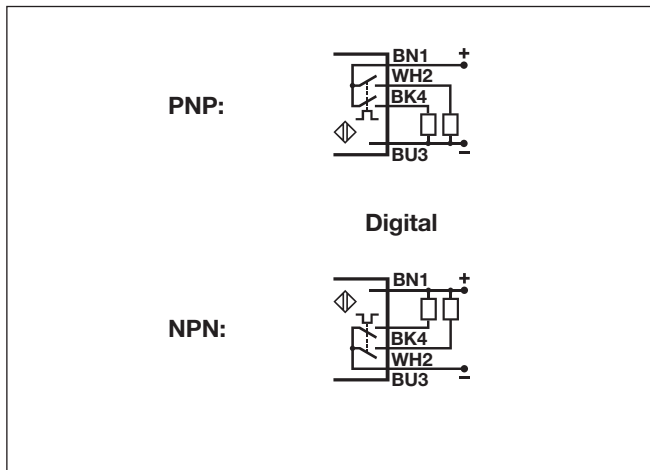

Detection Range

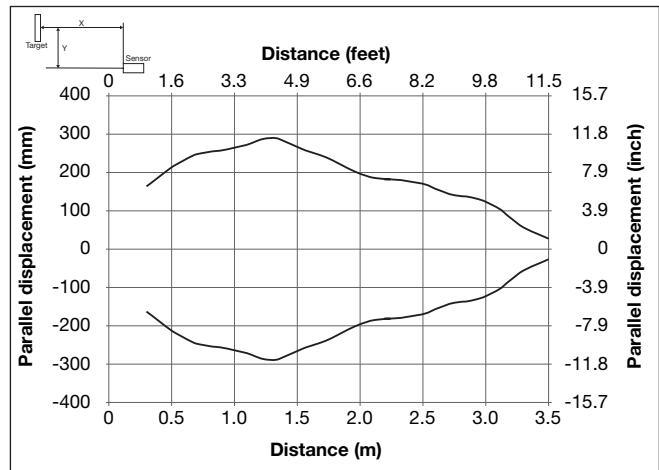

Dimensions

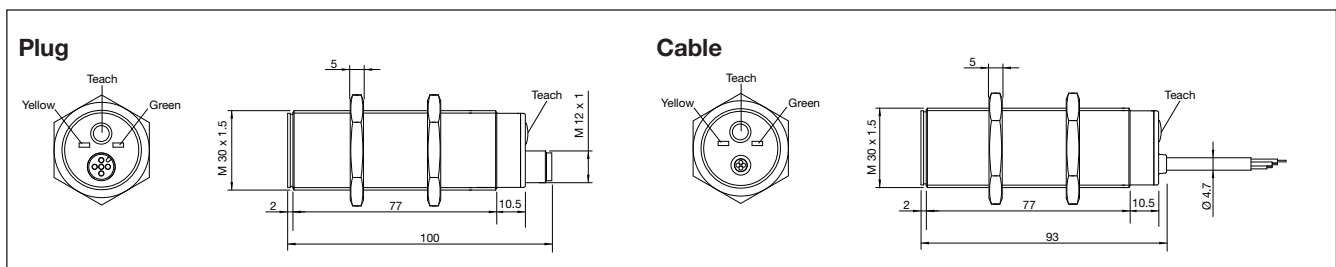

Programming setup

General set up of sensing point P1 (longest distance) and P2 (shortest distance) independently of the sensor type or function.

- 1) Mount the sensor in the selected application.
- 2) Place a target in front of the sensor at the maximum required distance (P1), then press shortly on the teach-button. The yellow LED switches Off and then On again after a maximum of 2 seconds. Now, the distance (P1) is saved in the sensor, and the target can be moved. I)
- 3) Place the target at the minimum distance requested (P2), then press shortly on the teach-button. The yellow LED turns Off and then flashes 5 times. Now, the distance (P2) is saved in the sensor and the target can be moved. II)

I) P1 can be set to maximum exceeding the family specification for the sensor by removing the target in front of the sensor. Push and hold the teach-button for more than one second and the sensing distance is set at a unique distance for this sensor only.

II) The second switch point can be set to minimum by setting the target within the blind zone close to the sensor head or by covering the sensor head with your hand while teaching P2.

Sensors with 2 digital outputs: UA..EAD..PP/NP types, Normal sensing function or Adjustable Hysteresis

- 1) The factory settings are normal sensing function.



- 2) Push and hold the teach-button for 12 seconds until the yellow LED flashes fast, then release the teach-button and the LED will flash 5 times to acknowledge the change in function. Now, the sensor is in adjustable hysteresis mode.

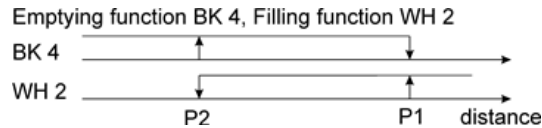

- 3) To switch back to normal function, repeat step 2.

Installation Hints

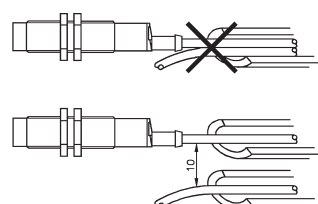
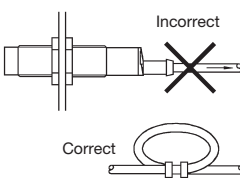
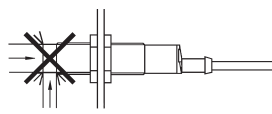
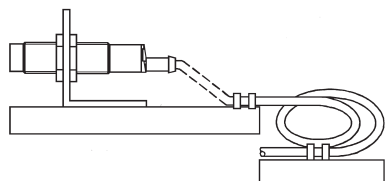
<p><i>To avoid interference from inductive voltage/current peaks, separate the prox. switch power cables from any other power cables, e.g. motor, contactor or solenoid cables</i></p> 	<p><i>Relief of cable strain</i></p>  <p>The cable should not be pulled</p>	<p><i>Protection of the sensing face</i></p>  <p>A proximity switch should not serve as mechanical stop</p>	<p><i>Switch mounted on mobile carrier</i></p>  <p>Any repetitive flexing of the cable should be avoided</p>
--	--	---	---

Delivery Contents

- Ultrasonic sensor: UA30EAD....
- Installation instruction
- Mounting: 2 x M30 Nuts
- **Packaging:** Carton box 35 x 107 x 173 mm

Accessories

- Connector type CONB14NF.. series