

2-3 Phase Compact Power Supply



Description

The SPDE two and three phases series of DIN-rail mount power supplies provide high performance within an extremely compact footprint. Power ratings start from 120 W up to 480 W with 24 and 48 VDC output. The SPDE achieves high operating efficiency of up to 95.6% @ 230 VAC. Features such as DC OK output relay and built-in protection functions ensure a high degree of reliability during operation.

All specifications are at nominal values, full load, 25°C unless otherwise stated.

Benefits

- **Compact dimensions.** SPDE can save up to 100% panel-width space thanks to its ultra-slim design. The 480 W model is just 80 mm wide.
- **High efficiency.** The built-in PFC results in high operating efficiency up to 95.6%.
- **Flexible installation.** Universal AC/DC input range with AC voltage (2-Ph 180 VAC to 600 VAC and 3-Ph 320 VAC to 600 VAC) or with DC voltage (2-Ph 254 VDC to 848 VDC and 3-Ph 450 VDC to 850 VDC).
- **Integrated protection.** Output short circuit, over-current, over-voltage, over-temperature protection.
- **Wide operating temperature.** SPDE 2 and 3-Ph models can work in extreme temperatures from -40°C to +70°C (-40°F to +158°F).

Applications

Installations with limited panel space, industrial equipment, machinery.

Main functions

- Output short circuit, over-current, over-voltage and over-temperature protection
- DC OK relay indication
- Built-in active PFC (only 2-Ph 240 W and 3-Ph 480 W)

References

Order code



SPDE R



Enter the code entering the corresponding option instead of .

Code	Option	Description	Notes
S	-	Switching	Device typology
P	-	Power	
D	-	DIN rail	Mounting
E	-	High efficiency	
<input type="checkbox"/>	24	24 VDC	Rated output voltage
	48	48 VDC	
<input type="checkbox"/>	120	120 W	Rated output power
	240	240 W	
	480	480 W	
<input type="checkbox"/>	2	2-phase input	Input type
	3	3-phase input	
R	-	Relay output	

Selection guide

Output Voltage	120 W	240 W	240 W	480 W
24 VDC	SPDE241202R	SPDE242402R	SPDE242403R	SPDE244803R
48 VDC	-	-	SPDE482403R	SPDE484803R

Further reading

Information	Where to find it	QR code
SPDE 2/3 phase datasheet	https://gavazziautomation.com/images/PIM/DATASHEET/ENG/SPDE2_3_DS_EN.pdf	
SPDE 2/3 phase installation sheet	https://gavazziautomation.com/images/PIM/MANUALS/ENG/SPDE2_3_IM.pdf	

Structure

SPDE..1202R, SPDE..2402R, SPDE..2403R

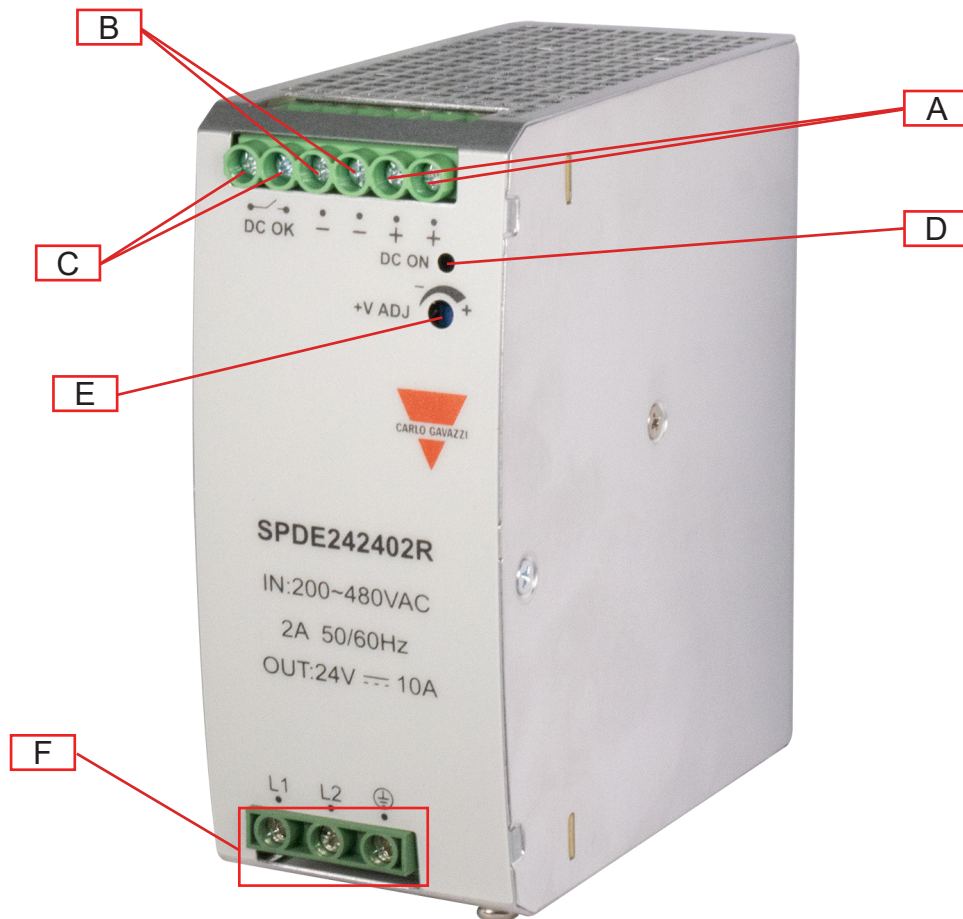

Element	Component	Function
A	+ V terminals	Positive DC Output terminals
B	- V terminals	Negative DC Output terminals
C	DC OK terminals	DC OK Output terminals
D	DC OK LED	Green status display LED lights, when output voltage is active
E	VADJ trimmer	Output voltage adjustment
F	Input terminals	L, N supply terminals and Protective Earth (PE)

SPDE..4803R



Element	Component	Function
A	+ V terminals	Positive DC Output terminals
B	- V terminals	Negative DC Output terminals
C	DC OK terminals	DC OK Output terminals
D	VADJ trimmer	Output voltage adjustment
E	DC OK LED	Green status display LED lights, when output voltage is active
F	Overload LED	Red status display LED lights, when the output is in Overload
G	Signal connection terminal	PC monitoring and remote control functions
H	Input terminals	L, N supply terminals and Protective Earth (PE)

Features

General data

	SPDE..1202R	SPDE..2402R	SPDE..2403R	SPDE..4803R
Leakage current	<3.5 mA	<1.0 mA	<2.0 mA	
Efficiency	91%		92%	95% (24 VDC) 95.6% (48 VDC)
Power loss @ nominal load	12 W	24 W	21 W	25 W
Power factor (full load)				
230 VAC	-	0.93	-	-
400 VAC	-	0.90	-	0.95
480 VAC	-	-	-	0.95
Ingress protection	IP20			
MTBF (MIL-HDBK-217F)	>300,000 h			≥ 250,000 h
Case material	Metal			
Weight	550 g	790 g	750 g	1250 g

Dimensions

SPDE..1202R

Unit: mm [inch]

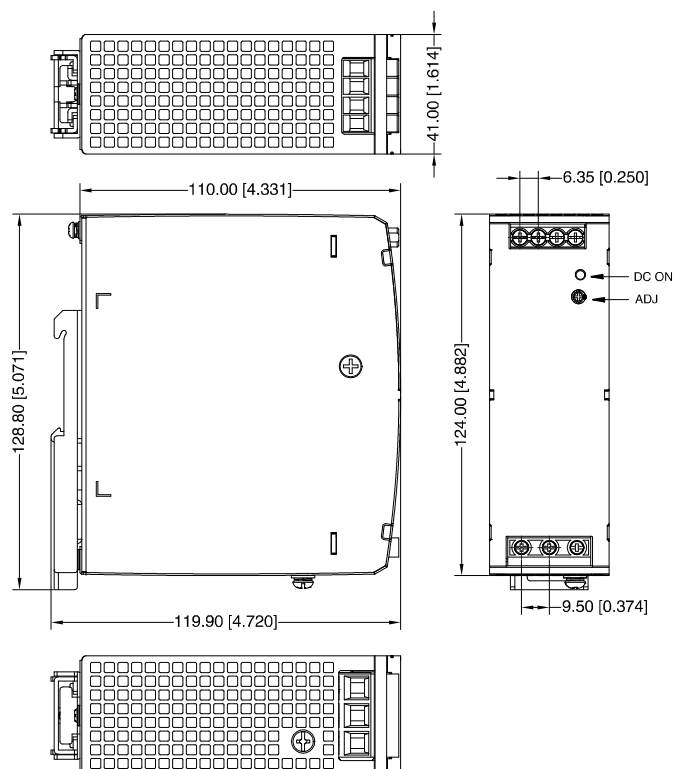

SPDE..2402R
 Unit: mm [inch]

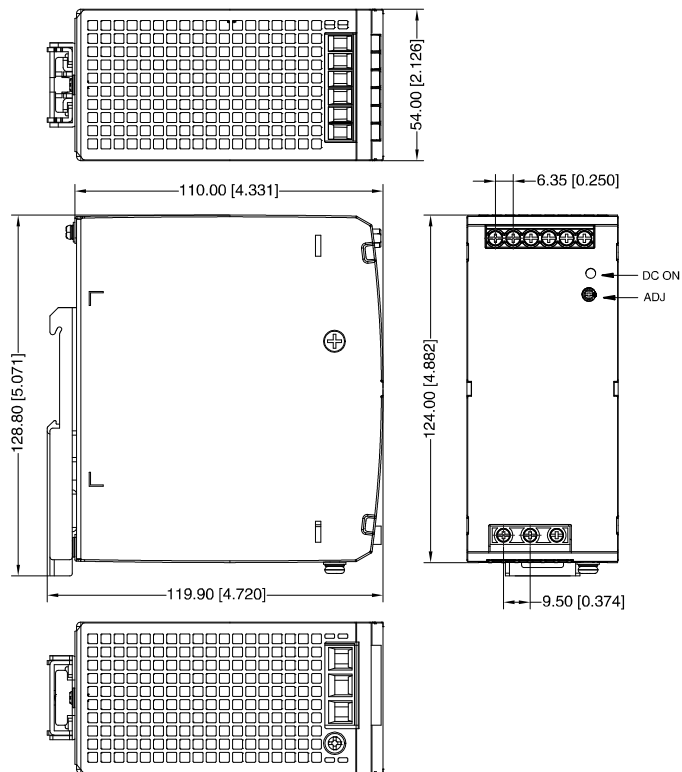

SPDE..2403R
 Unit: mm [inch]

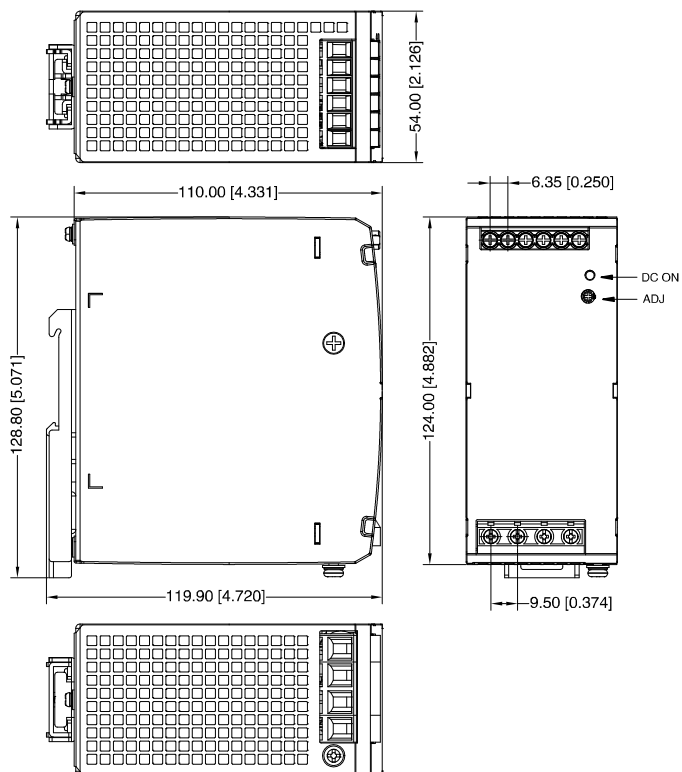

SPDE..4803R
 Unit: mm [inch]

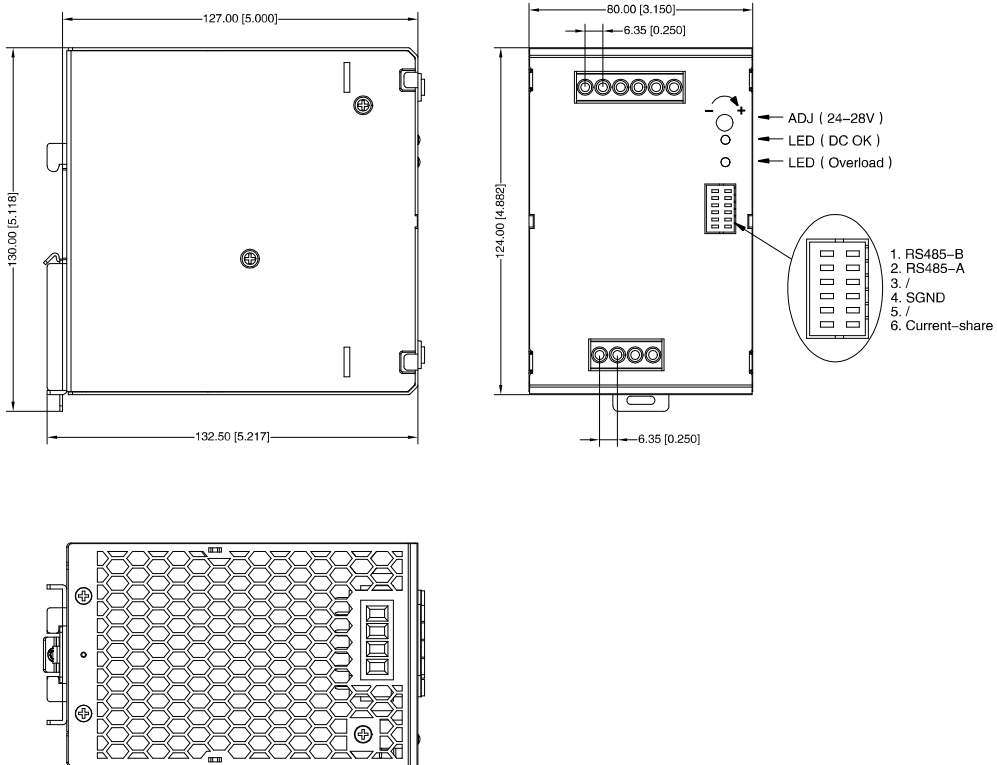

Connection diagram

Terminal markings

SPDE241202R

Terminal	Designation	Description
1	+V _o	Positive output terminal
2	-V _o	Negative output terminal
3, 4	DC OK	DC OK Contact Relay
5	AC(L1)	Input terminals (L1 phase conductor, no polarity with DC input)
6	AC(L2)	Input terminals (L2 phase conductor, no polarity with DC input)
7	PE	Ground this terminal to minimize high frequency emissions

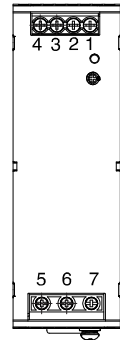

SPDE482402R

Terminal	Designation	Description
1, 2	+V _o	Positive output terminal
3, 4	-V _o	Negative output terminal
5, 6	DC OK	DC OK Contact Relay
7	AC(L1)	Input terminals (L1 phase conductor, no polarity with DC input)
8	AC(L2)	Input terminals (L2 phase conductor, no polarity with DC input)
9	PE	Ground this terminal to minimize high frequency emissions

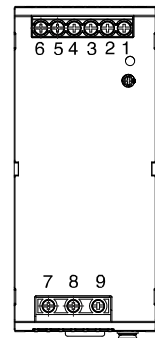

SPDE..2403R

Terminal	Designation	Description
1, 2	DC OK	DC OK Contact Relay
3, 4	-V _o	Negative output terminal
5, 6	+V _o	Positive output terminal
7	L1 / DC +	Input terminals (L1 phase conductor, no polarity with DC input)
8	L2 / DC -	Input terminals (L2 phase conductor, no polarity with DC input)
9	L3	Input terminals (L3 phase conductor, no polarity with DC input)
10	PE	Ground this terminal to minimize high frequency emissions

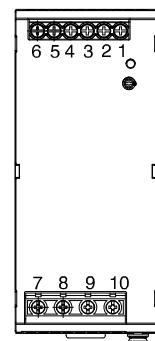

SPDE..4803R

Terminal	Designation	Description
1, 2	DC OK	DC OK Contact Relay
3, 4	-V _o	Negative output terminal
5, 6	+V _o	Positive output terminal
7	L1	Input terminals (L1 phase conductor, no polarity with DC input)
8	L2	Input terminals (L2 phase conductor, no polarity with DC input)
9	L3	Input terminals (L3 phase conductor, no polarity with DC input)
10	PE	Ground this terminal to minimize high frequency emissions

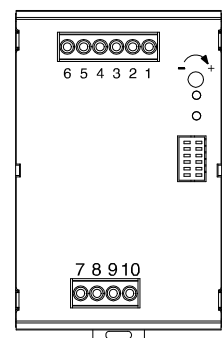

Signal connection terminal (only SPDE..4803R)

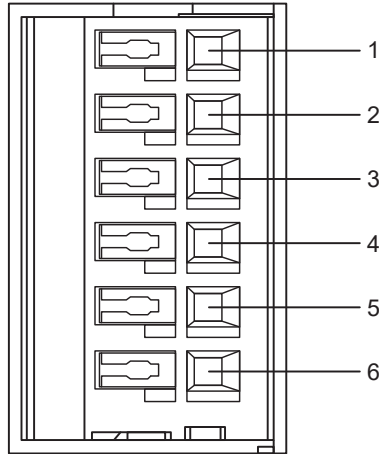

Pin	Mark	Features
1	RS485_H	Serial communication
2	RS485_L	
3	/	/
4*	SGND	Signal terminal reference ground
5	PS_ON	Remote control signal
6	C.S	Current sharing

Note: *The reference ground of all pins on the signal terminal is pin 4.

Remote control switch (only SPDE..4803R)

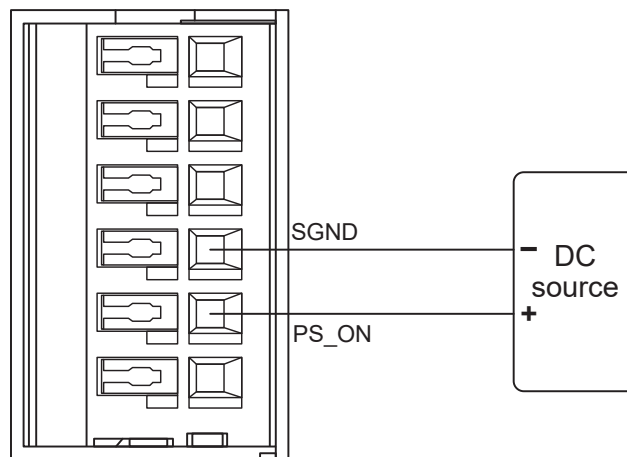

Designation	Description
Output status	Between PS_ON (pin 5) and SGND (pin 4) switch
Normal output	DC source power supply voltage is less than 0.8 VDC
Output OFF	DC source supply voltage is greater than 4 VDC and less than 20 VDC

If the power module is connected to the power supply, it can be controlled by the external voltage between the PS_ON signal pin and SGND.

PC monitoring (only SPDE..4803R)

In a parallel system, if you need to identify the information of the power modules, you need to monitor each parallel power module by the host computer. The connection diagram is as follows:

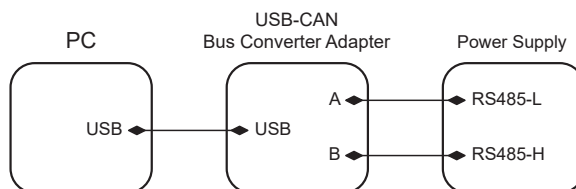

Connect the RS485-L and RS485-H of the signal terminal to the USB interface module. When the host computer communication is turned on, execute the EXE application "Carlo Gavazzi ModbusMonitor V1.01" to visualize as the following picture. It is needed to select the correct serial port and baud rate in order to check the information available via S/W.

Power supply ON - the signal communication in the bottom of the image is active:

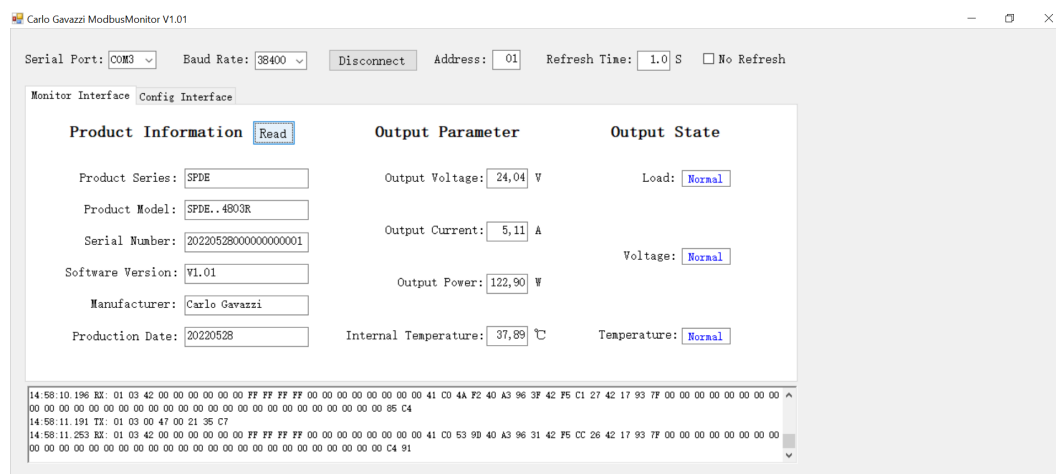

Power supply OFF - the signal communication in the bottom of the image is interrupted:

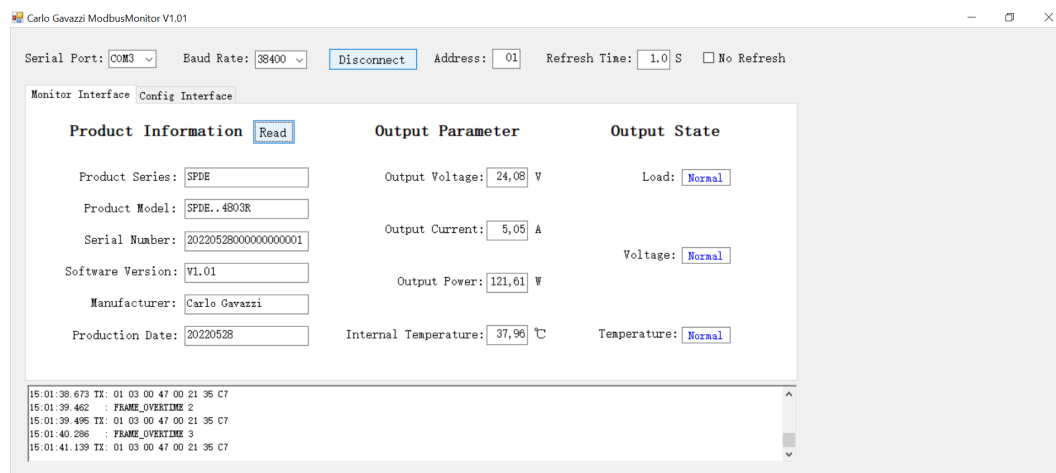

Note: After the serial port is successfully opened, the information of "output parameter" and "output state" will be automatically obtained, and the "product information" needs to be manually clicked on the read case after the "product information".

PC monitoring (continued)

Configuration interface: this function is used for multiple SPDE..4803R connected in parallel. The S/W can assign the address for different SPDE..4803R to communicate in RS485. It is possible to assign the address numbers from 01 – 254.

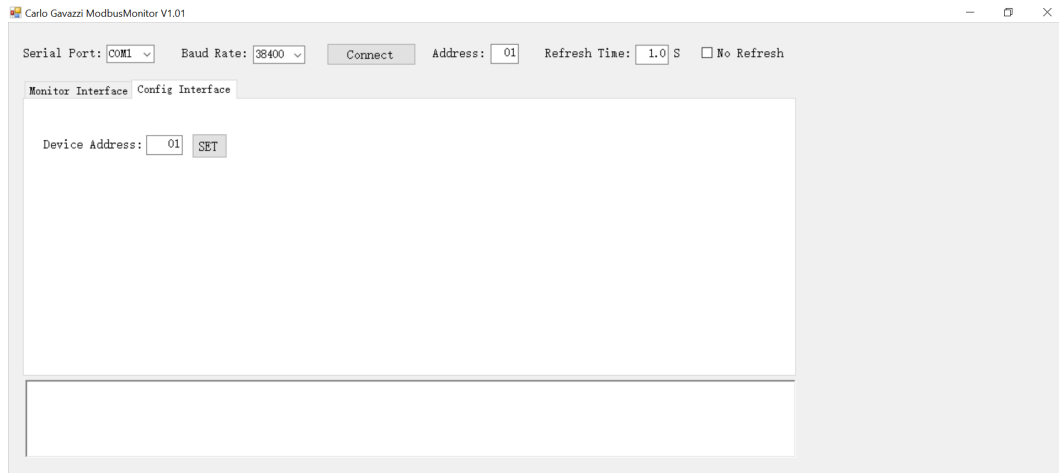

Environmental specifications

	SPDE..1202R	SPDE..2402R	SPDE..2403R	SPDE..4803R
Operating temperature	-25°C to 70°C -13°F to 158°F	-40°C to 70°C -40°F to 158°F	-30°C to 70°C -22°F to 158°F	
Storage temperature	-40°C to 85°C -40°F to 185°F			
Humidity	<95% RH Non-condensing			
Altitude	5000 m			
Temperature derating	Refer to derating diagram			

Compatibility and conformity

	SPDE..1202R	SPDE..2402R	SPDE..2403R	SPDE..4803R
Safety standards	EN62368-1, UL61010, UL61010-1			
Approvals				
Conducted (CS) IEC/EN 61000-4-6	10 Vrms (PC A)			
Voltage dips and interruptions IEC/EN61000-4-11	0% (PC B) 70% (PC B)			
EMC emission CE: CISPR32/EN55032 RE: CISPR32/EN55032	CLASS B CLASS B			
Harmonic current	IEC/EN61000-3-2 CLASS A			
EMC immunity	EN61000-4-2, EN61000-4-3, EN61000-4-4, EN61000-4-5, EN61000-4-6, EN61000-4-11			
Vibration resistance	10 ~ 500 Hz, 2G, 10 min. / 1 cycle, period for 60 min. Each along X, Y, Z axes.			
Semi F47	Tolerated sags to 50% of equipment nominal voltage for duration of up to 200 ms			

Insulation

	SPDE..1202R	SPDE..2402R	SPDE..2403R	SPDE..4803R
Insulation / withstand voltage (input / GND)	2.0 kVAC / < 10 mA	2.0 kVAC / < 5 mA	2.5 kVAC / < 15 mA	2.5 kVAC / < 5 mA
Insulation / withstand voltage (input / output)	4.0 kVAC / < 10 mA	4.0 kVAC / < 5 mA	4.0 kVAC / < 10 mA	4.0 kVAC / < 5 mA
Insulation / withstand voltage (output / GND)	0.5 kVAC / < 10 mA	0.5 kVAC / < 5 mA	0.5 kVAC / < 15 mA	0.5 kVAC / < 10 mA
Output / DC OK	0.5 kVAC / < 2 mA			0.5 kVAC / < 1 mA
Insulation resistance	≥ 100 MΩ			≥ 50 MΩ
Overvoltage category	III (UL508)	III (EN62477)		I (EN61010)
Pollution degree	2			

Inputs

	SPDE..1202R	SPDE..2402R	SPDE..2403R	SPDE..4803R
Rated input voltage	230 VAC to 400 VAC		400 VAC to 500 VAC	
Input voltage range	180 VAC to 600 VAC	180 VAC to 550 VAC	320 VAC to 600 VAC	
	254 VDC to 848 VDC	254 VDC to 780 VDC	450 VDC to 850 VDC	450 VDC to 800 VDC
AC current (max)	<1.4 A (230 VAC) <1.0 A (400 VAC)	<2.0 A (230 VAC) <1.0 A (400 VAC)	<0.85 A (400 VAC) <0.75 A (500 VAC)	<1.0 A (400 VAC) <0.8 A (480 VAC)
Frequency range	47 Hz to 63 Hz			
Inrush current	50 A (400 VAC) Cold start	<110 A (400 VAC) Cold start	<60 A (400 VAC) Cold start	<10 A (400 VAC) <10 A (480 VAC) Cold start

Outputs

	SPDE..1202R	SPDE..2402R	SPDE..2403R	SPDE..4803R
Output power	120 W	240 W		480 W
Voltage accuracy	±1.0 %			
Line regulation	±0.5 %			
Load regulation	±0.5 %	±1.0 %		±0.5 %
Voltage regulation span 24 VDC 48 VDC	24 V to 28 V		24 V to 28 V 48 V to 55 V	24 V to 28 V 48 V to 56 V
Rated output current 24 VDC 48 VDC	5 A -	10 A -	10 A 5 A	20 A 10 A
Ripple and noise 20 MHz bandwidth 24 VDC 48 VDC	< 120 mV -	< 150 mV -	100 - 150 mV 150 - 200 mV	100 mV
Hold up time	10 ms (230 VAC) 50 ms (400 VAC)	18 ms (230 VAC) 18 ms (400 VAC)	10 - 20 ms (400 VAC) 30 - 40 ms (500 VAC)	18 - 22 ms (400 VAC) 18 - 22 ms (480 VAC)
Set-up time	< 2 s (400 VAC)	1.5 - 3.0 s (230 VAC) 0.8 - 1.5 s (400 VAC)	< 1.5 s	< 1.5 s (400 VAC)
Rise time	< 100 ms			
Turn-on overshoot	< 10 % Vo			
Overshoot and undershoot	< 10 % Vo			
Remote control switch / PC monitoring	No			Yes
Mounting space	No requirement for the installation distance		Top / bottom: 20 mm lateral: 5 mm (when the device is loaded permanently with more than 50% of the rated power)	
Series operation	Support output series boost voltage, it is suggested additional 15 mm space			
Parallel operation	No			Yes, max. 3 pcs, it is suggested additional 15 mm space
Power boost	150 % peak load for 3 s	150 % peak load for 5 s	130 % peak load for 3 s	150 % peak load for 4.5 s

Series operation

Keep a 15 mm (left/right) installation gap between the two power supplies and avoid installing the power supplies on top of each other. Do not connect the power supplies in series in an installation orientation other than the standard installation orientation (input terminals down).

Note that leakage current, electromagnetic interference, inrush current and harmonics will increase when multiple power supplies are used. Refer to the figure below for the wiring method:

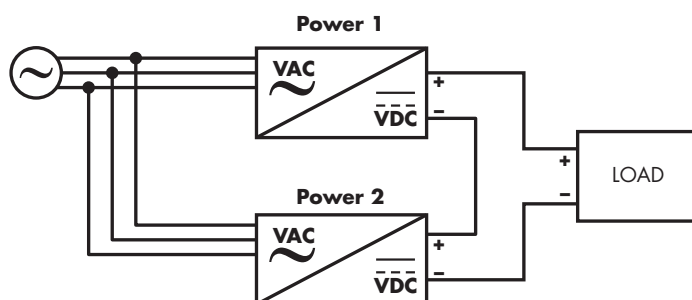

Parallel operation (only SPDE..4803R)

Redundancy

Power module outputs can be connected in parallel for redundancy, increasing system reliability. The maximum power of the redundant system needs to be derated to ensure that the redundant system can still meet the rated load requirements when a power supply module fails. Currently, the common practice is to build a redundant system by the N+1 method, that is, N+1 power supplies are connected in parallel. Support the maximum load current $N \cdot I_{o_max}$, where I_{o_max} is the rated output current of each power supply, for example, the rated output current of each power supply is 20 A, and 2+1 are connected in parallel, thus constructing a $2 \cdot 20A = 40A$ redundant system.

The power module supports 2+1 parallel redundant operation.

The Oring circuit is used inside the power module, and when any one of the power modules in parallel fails, it will not affect the work of other power modules.

Current Share

The current sharing bus (current_share) between multiple machines is short-circuited with each other, and SGND is short-circuited with each other at the same time.

The output voltage difference of each single module is less than or equal to 100 mV, and a better comprehensive effect of line terminal output voltage and current sharing can be obtained. The wiring method of the current sharing function is shown in the following figure:

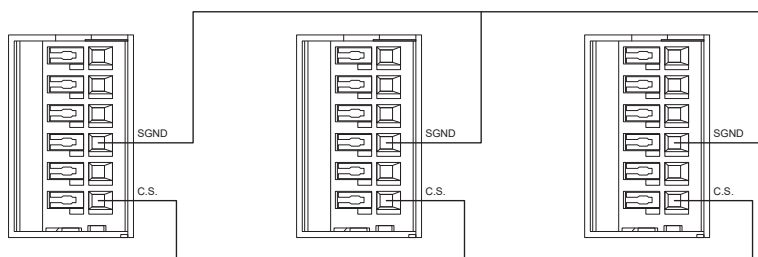

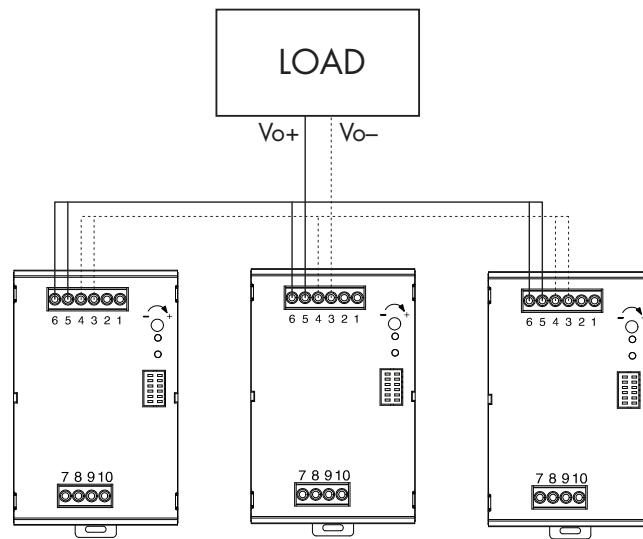

Note:

1. When used in parallel, the number of parallel modules cannot exceed 3.
2. When the power modules work in parallel, there is an active current sharing circuit inside to ensure that the current between each module remains balanced.

The active current sharing circuit adopts the automatic master-slave current sharing method. Each power supply module has a current sharing bus signal (C.S). When working in parallel, the current sharing buses of all power modules must be connected together. The current sharing bus signal is located at pin 5 of remote control switch. At the same time, it is necessary to connect the signal terminals SGND of the power module together, and the SGND of the signal terminal is located at pin 4 of remote control switch.

The output voltage of each power module will affect the current sharing accuracy. The output voltage of the power module is rated voltage ± 100 mV. In practical applications, if the output voltage value needs to be adjusted, the output voltages of all parallel power modules need to be adjusted to the same voltage. The recommended voltage range is: target voltage value ± 100 mV.

After the output load of each power module is greater than 50% of the rated load, the current sharing accuracy is required to be $\pm 5\%$. The calculation formula of current sharing is:

$$\text{Power supply 1's average accuracy} = \frac{I_{o1} - (I_{o1} + I_{o2})/2}{(I_{o1} + I_{o2})/2} * 100\%$$

$$\text{Power supply 2's average accuracy} = \frac{I_{o2} - (I_{o1} + I_{o2})/2}{(I_{o1} + I_{o2})/2} * 100\%$$

I_{o1} : The output current value of the power supply 1 in the parallel power module.

I_{o2} : The output current value of the power supply 2 in the parallel power module.

DC_OK signal

The DC_OK signal is used to monitor whether the power supply is working normally. This signal is on the DC_OK pin of the output terminal DC OK relay contact. When the output is greater than 95% of the rated voltage of the output, the DC_OK signal is activated, the DC_OK at the output terminal is connected, and the green light is on at the same time. When the output voltage is less than 90% of the rated voltage of the output, the DC_OK of the output terminal is disconnected, and the green light is off at the same time.

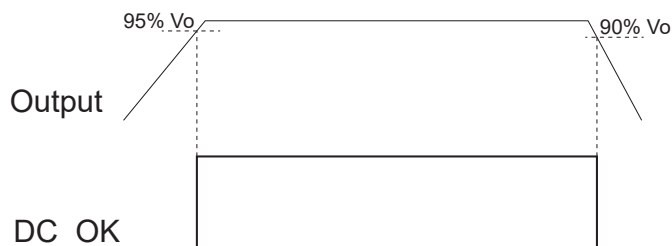

3-phase 2-wire systems

SPDE..4803R models can also be used for permanent operation of two-wire in a three-phase system.

When operating the two-wire in a three-phase system, the output power must be derated according to the following curve, and the input operating voltage can only operate at 340VAC-600VAC. Exceeding this derating limit for a long time will cause the power supply to overheat and shut down.

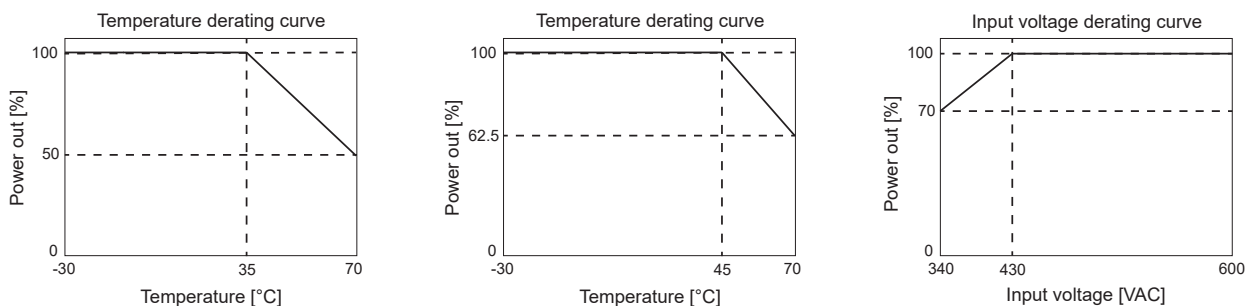

Note:

Basic performance such as electromagnetic compatibility performance, hold-up time, loss and output ripple are different from three-phase operation. This working method is not covered in the certification, and operation two wires in a three-phase system does not meet the safety certification.

Performance

Current derating

SPDE..1202R

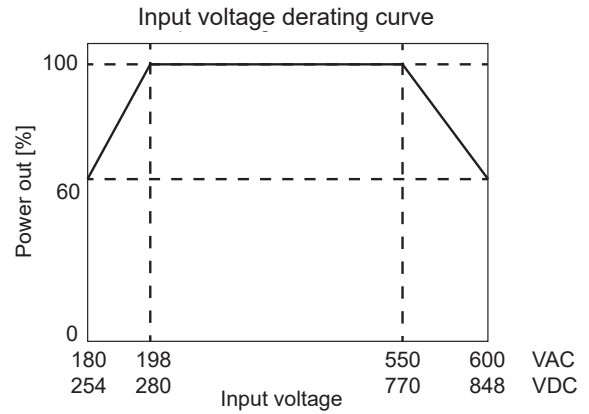
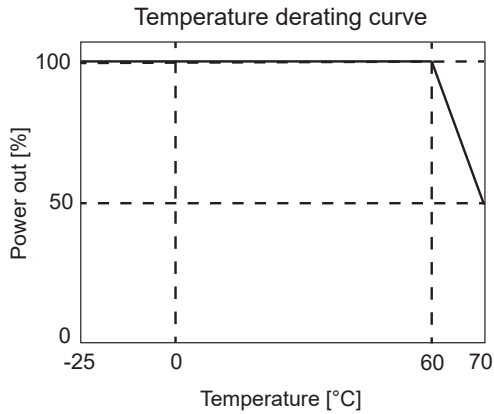

SPDE..2402R

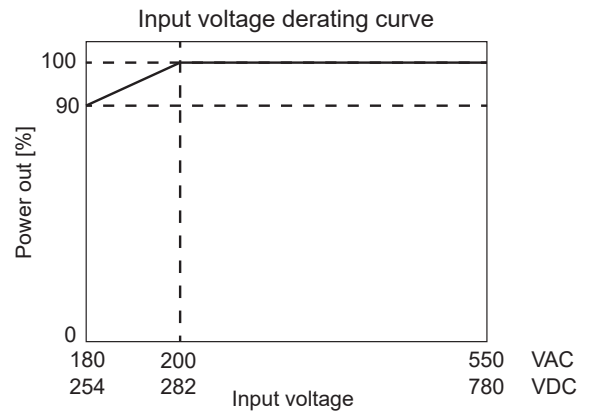
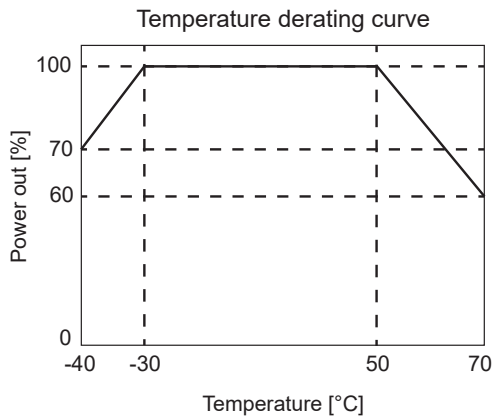

SPDE..2403R

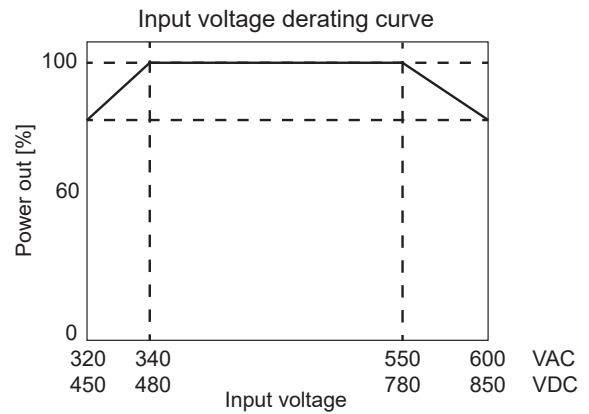
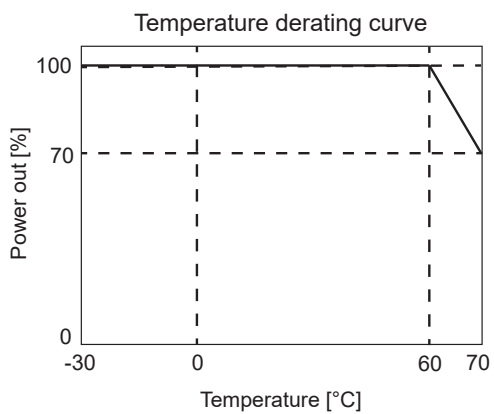

SPDE..4803R

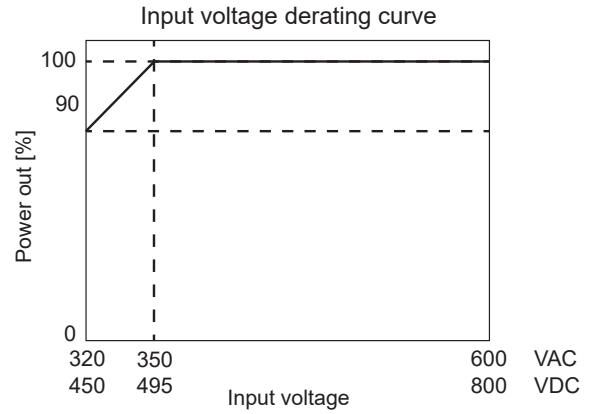
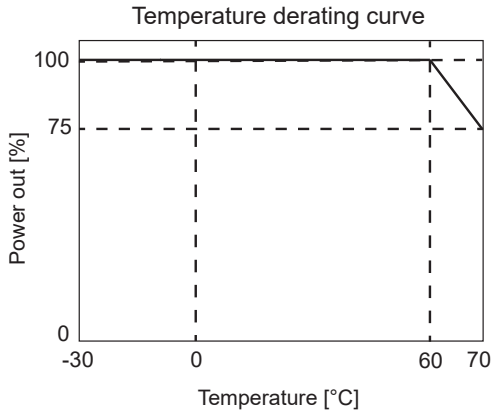

Efficiency

SPDE..1202R

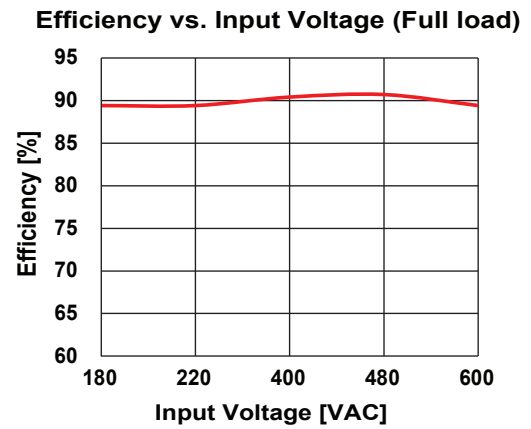
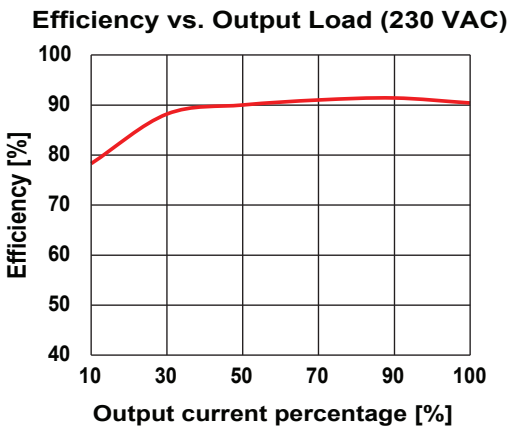

SPDE..2402R

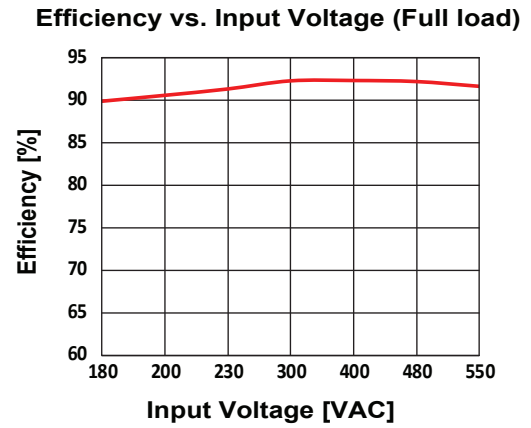
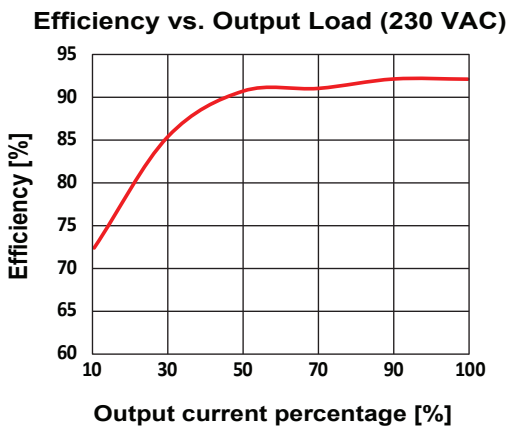

SPDE..2403R

Efficiency vs. Output Load (400 VAC)

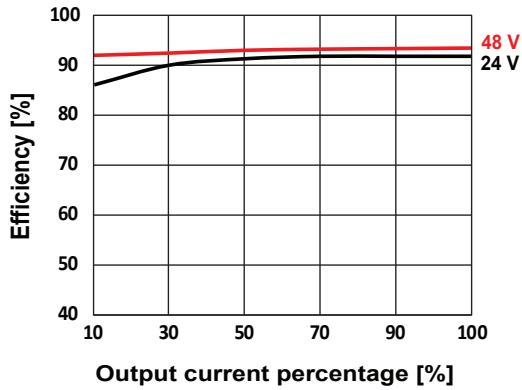

Efficiency vs. Input Voltage (Full load)

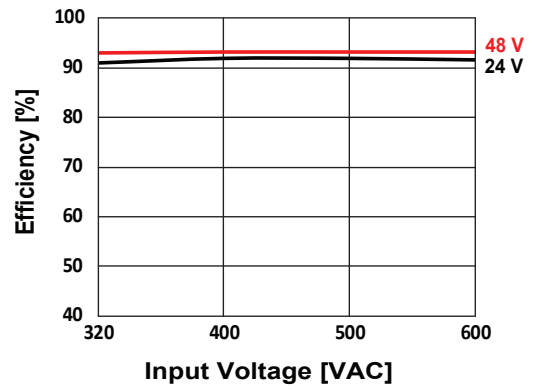

SPDE..4803R

Efficiency vs. Output Load (400 VAC)

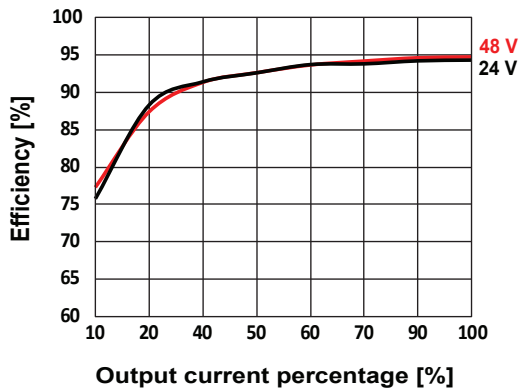

Efficiency vs. Input Voltage (Full load)

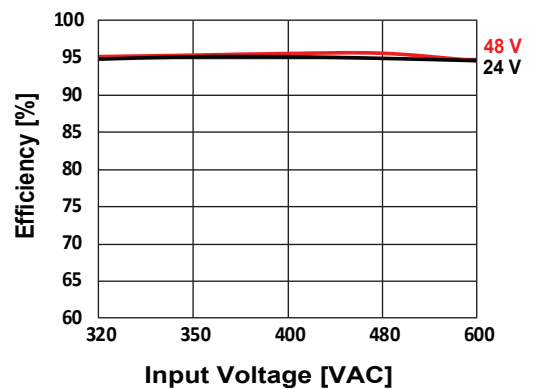

Wiring diagram

SPDE..2R

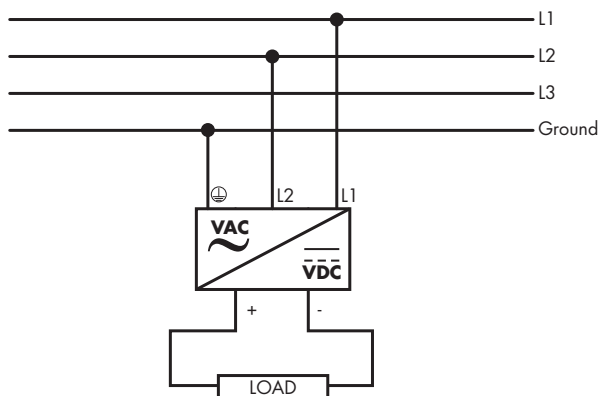

Any of two wires can be connected:
(L1/L2), (L2/L3), (L1/L3)

SPDE..3R

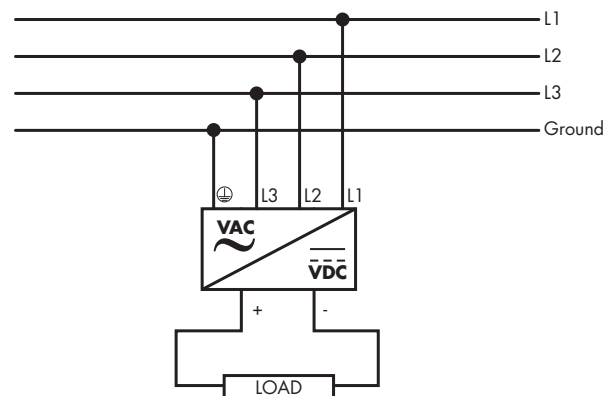

All three wires have to be connected.

Connection specification

	SPDE..1202R	SPDE..2402R	SPDE..2403R	SPDE..4803R	
Terminal type	Screw terminals with Phillips screw head				
Screw driver blade	3.5 mm slotted or Phillips				
Input tightening torque (recommended)	< 0.5 Nm	< 1.0 Nm		< 0.5 Nm	
Output tightening torque (recommended)		< 0.5 Nm			
Conductor cross section (input terminals)	0.13 - 6 mm ² (26 - 10 AWG)	0.2 - 6 mm ² (24 - 10 AWG)		0.08 - 6 mm ² (28 - 10 AWG)	
Conductor cross section (output terminals)	24 V	0.52 - 6 mm ² (20 - 10 AWG)	-		1.3 - 6 mm ² (16 - 10 AWG)
	48 V	-	0.8 - 6 mm ² (18 - 10 AWG)		
DC OK relay output	0.2 - 1.3 mm ² (24 - 16 AWG)			-	

Block diagram

SPDE..2R

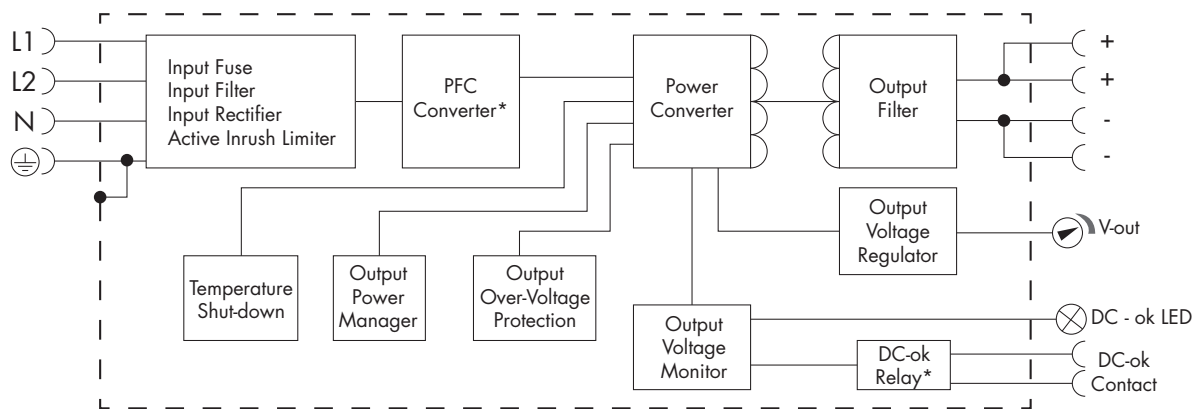

SPDE..3R

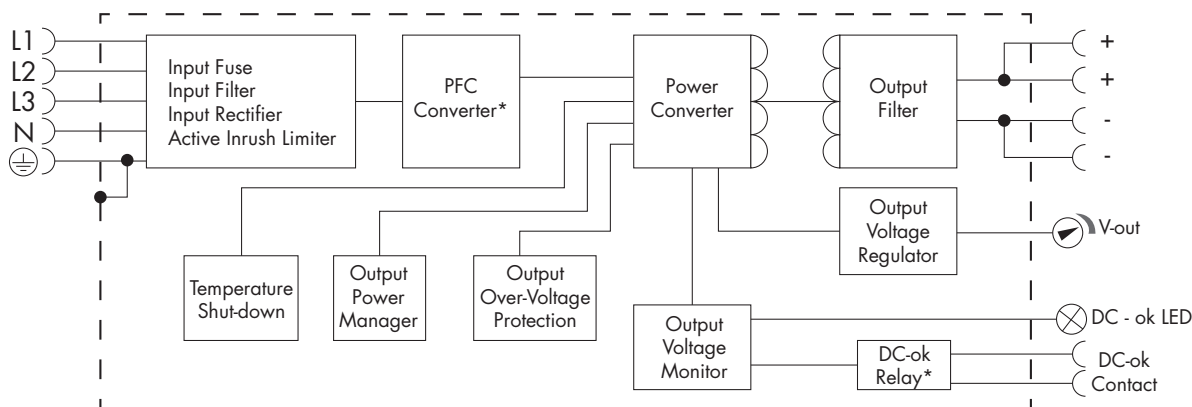

* only in SPDE242402R, SPDE244803R and SPDE484803R

Operating description

Control and protection

	SPDE..1202R	SPDE..2402R	SPDE..2403R	SPDE..4803R
Overvoltage protection	≤ 35 V	≤ 65 V	≤ 36 V (24 VDC) ≤ 65 V (48 VDC)	≤ 35 V (24 VDC) ≤ 60 V (48 VDC)
	Output voltage hiccup	Output voltage clamp or hiccup	Output voltage hiccup, self-recovery	
Over-current protection	≥150 % of rated current: hiccup, self-recovery		≥130 % of rated current: hiccup mode after constant current operation for 3 s, self-recovery	120 - 150 % of rated current: constant current mode after 4.5 s of normal output, automatic recover after fault condition is removed ≥150 % of rated current: constant current mode, automatic recover after fault condition is removed
Short circuit protection	Constant current hiccup, self-recovery	Hiccup, continuous, self-recovery	Hiccup mode after constant current operation for 3 s, continuous, self-recovery	Continuous, self-recovery
Over temperature protection	Output voltage turn off, recovery after restart	Output voltage turn off, self-recovery	Start: 85°C Release: 50°C	Start: 85°C Release: 65°C