

# Dupline® Field- and Installationbus Dupline Profibus-DP Gateway Type G 3891 0020

CARLO GAVAZZI



- Built-in Dupline channel generator
- PROFIBUS-DP slave according to EN 50 170
- Certified by the PNO
- PROFIBUS-DP communication speed of up to 12 MBaud
- Read/control 128 Dupline inputs/outputs through PROFIBUS-DP
- Split-I/O mode selectable (128 inputs *and* 128 outputs)
- Signals from AnaLink sensors available on the DP-network
- For mounting on DIN-rail (EN 50 022)
- LED indicators for supply, Dupline carrier and fault
- AC power supply

## Product Description

Dupline Channel Generator with the function of a PROFIBUS-DP slave. This means that the 128 Dupline I/O's (incl. AnaLink) can be read/controlled by PROFIBUS-DP masters (PLC's, PC interface cards, etc. from various sup-

pliers). Several Dupline gateways can be connected to the same PROFIBUS-DP network. The unit is certified by PNO (Profibus Nutzer Organisation) which ensures compatibility and interoperability with other PNO-certified products.

## Ordering Key **G 3891 0020 230**

Type: Dupline \_\_\_\_\_  
Type no. \_\_\_\_\_  
Supply \_\_\_\_\_

## Type Selection

Supply	Ordering no.
115/230 VAC	<b>G 3891 0020 230</b>

## Input/Output Specifications

PROFIBUS-DP		RS 485
Pin assignment	A	9-pole female SUB-D Pin 8
	B	Pin 3
	RTS	Pin 4
	+5V	Pin 6
	GND	Pin 5
Baudrate		Auto detection
Cable length		100 m @ 12 MBaud
		200 m @ 1.5 MBaud
		1200 m @ 93.75 kBaud
Up-date time (128 digital I/O)		Typ. 200 µs at 12 MBaud
		Typ. 1.6 ms at 1.5 MBaud
Dielectric voltage		
PROFIBUS-DP Dupline		≥ 4 kVAC (rms)
PROFIBUS-DP ID-no.		6590
GSD-file		GDUP6590.GSD
<b>Dupline</b>		
Output voltage		8.2 V
Output current		≤ 100 mA
Short-circuit protection	Yes	
Output impedance		≤ 15 Ω
Sequence time		
8 digital I/O		15.2 ms
128 digital I/O		132.3 ms
AnaLink value update time		
8 signals		3.9 s
128 signals		33.8 s

Adjustments	
2 x 10 pos. rotary switch	PROFIBUS Slave Address Range 02 to 99
1 x 16 pos. rotary switch	No. Dupline channels 8 .. 128 in steps of 8
DIP-switch 1	Dupline mode (Normal/Split I/O)
DIP-switch 2	Dupline data transfer mode
DIP-switch 3	Analog protocol
DIP-switch 4	Not used
<b>Approvals</b>	
PROFIBUS operability	PNO (Profibus Nutzer Organisation)
Electrical safety	UL, CSA
<b>Conformity</b>	
CE	EMC Industrial Environment

## General Specifications

<b>Power ON delay</b>	< 2.5 s until start of Dupline carrier. < 40 s until correct reading of AnaLink values
<b>Indication for</b>	
Supply ON	LED, green
Dupline carrier	LED, yellow
Fault	LED, red
<b>Environment</b>	
Degree of protection	IP 20
Pollution degree	3 (IEC 664)
Operating temperature	0° to +50°C (+32° to +122°F)
Storage temperature	-20° to +85°C (-4° to +185°F)
<b>Humidity (non-condensing)</b>	20 to 80% RH
<b>Mechanical resistance</b>	
Shock	15 G (11 ms)
Vibration	2 G (6 to 55 Hz)
<b>Dimensions</b>	
<b>Material</b>	H8-housing
<b>Weight</b>	540 g

## Supply Specifications

<b>Power supply</b>	Overvoltage cat. III (IEC 664)
Rated operational voltage through term. 21, 22, 23 & 24	See wiring diagram
230	230 VAC ± 15% (IEC 38)
115	115 VAC ± 15% (IEC 38)
Frequency	45 to 65 Hz
Rated operational power	11 VA
Rated impulse withstand voltage	230 4 kV 115 2.5 kV
Dielectric voltage	
Supply - Dupline	≥ 4 kVAC (rms)
Supply - RS 485	≥ 4 kVAC (rms)

## Wiring Diagrams

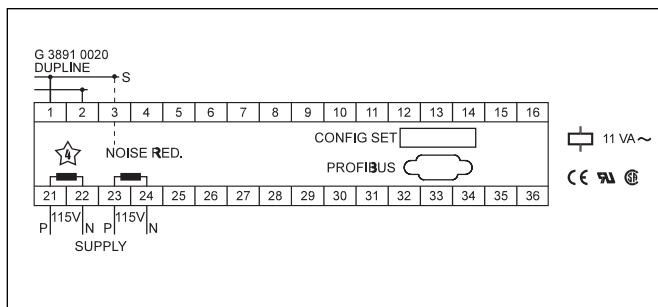
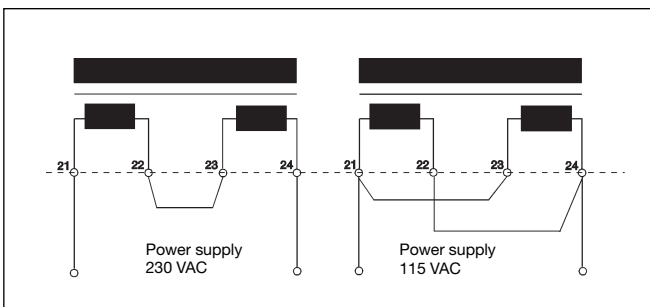

## Mode of Operation

The Dupline PROFIBUS-DP Gateway is a Dupline channel generator with the function of a PROFIBUS-DP slave according to EN 50 170. This means that the 128 Dupline I/O's (incl. AnaLink) can be read/controlled by PROFIBUS-DP masters like PLC's and PC interface-cards from many different suppliers. Several Dupline gateways can be connected to the same PROFIBUS-DP network and operate together with other PROFIBUS-DP modules like operatorpanels, MMI's, frequency inverters, I/O-modules etc.

The Dupline PROFIBUS-DP Gateway is approved by the PNO (Profibus Nutzer Organi-

sation) that ensures compatibility with other PNO-certified products.

### Configuration Switches

The unit is equipped with the following configuration switches (see also Switch settings):

1 x 16-position rotary-switch for selecting the **Number of Dupline channels** in the range 8..128 (in steps of 8). The selected letter indicates the last channel group available on Dupline. If e.g. H is selected, the 64 channels in groups A..H will be available.

2 x 10-position rotary switch for selection of the **PROFIBUS-DP Slave Address** in

the range 02..99. (00..01 are reserved). Each module connected to PROFIBUS-DP must have a unique slave address which enables the PROFIBUS-DP Master to access the modules individually.

1 x DIP-switch for selection of **Dupline Operation Mode**. In "Normal" mode, Dupline operates as a peer-to-peer system where the channel generator automatically establishes a connection between Dupline-inputs and Dupline-outputs which are coded to the same Dupline-address. If e.g. an input coded for B5 is activated, the output(s) coded for B5 will also be activated.

Consequently, a Dupline-output can either be activated through the output-data received on PROFIBUS-DP or by an active Dupline input coded for the same Dupline-address.

In "Split I/O" mode, the Dupline-inputs and Dupline-outputs are treated independently by the channel generator. If e.g. an input coded for B5 is activated, the Gateway will make the information available on PROFIBUS-DP (like in normal mode), but it will not automatically activate the Dupline-output(s) coded to B5. The Dupline-outputs are controlled exclusively through the output data received on PROFIBUS-DP.



## Mode of Operation (cont.)

In this mode, up to 128 Dupline inputs and 128 Dupline outputs are available, since an input and an output coded to the same Dupline-address can operate independently.

### 1 x DIP-switch for selection of Dupline Data Transfer Mode.

If "Sequence-wise" is selected, the transfer of data between Dupline and PROFIBUS-DP only takes place inbetween Dupline I/O scan-sequences. This means that the Dupline I/O-data transmitted on PROFIBUS-DP will always originate from the same I/O scan-sequence. This mode must be selected if bit-combinations representing e.g. analog values are transmitted on Dupline. If "Bit-wise" is selected, then the transfer of data between Dupline and PROFIBUS-DP takes place continuously on-line with the Dupline I/O scan-sequences. In this way, the data-transfer speed between Dupline and PROFIBUS-DP is optimized. The "Bit-wise" mode should be selected if no bit-combinations representing analog values are transmitted on Dupline.

**Note:** It is allowed to use AnaLink sensors/transmitters in "Bit-wise" mode, since the AnaLink values are not transmitted as bit-combinations.

1 x DIP-switch for selection of **Analog Protocol** to either AnaLink (8-bit format) or multiplex (16-bit format). The Gateway will only transfer analog values from modules using the selected protocol. If multiplex is selected, the Gateway will automatically perform the required multiplexing on channels A1-A4. Because of this, these 4 channels are not available as outputs when the multiplex protocol is selected.

### Dupline Input Data

A part of the Gateway input-processor reads all the 128 Dupline-channels as digital inputs (16 bytes) and another part reads all the 128 Dupline-channels as analog inputs. If the AnaLink analog protocol is selected, 128 analog input-bytes will be available, since it takes one byte to represent one AnaLink value. If the multiplex analog protocol is

selected, 224 analog input-bytes will be available, since it takes two bytes to represent one of the up to 112 multiplex values.

All digital and analog inputs can be transmitted on PROFIBUS-DP. Since the user knows which channels are used as digital and which channels are used as analog, he also knows where to find the meaningful data on PROFIBUS-DP. If e.g. an AnaLink temperature sensor is coded for channel B5, the temperature value must be read in the AnaLink data-area. The status of channel B5 can also be read in the digital data-area, but the data will not be meaningful.

A part of the PROFIBUS-DP **Master configuration** is to define how many input-bytes the Master shall receive from each slave-module in the system. If e.g. no analog transmitters are connected to a Gateway, it can be defined that only the 16 bytes containing digital data shall be transmitted. In this way, the transmission of the analog input-

bytes without meaningful information is avoided.

In the first table below, it is defined how to read the digital status of the individual Dupline-channels on PROFIBUS-DP. The digital input-data are always transmitted as the first 16 bytes (byte-addresses 0..F). The number of analog input-bytes depends on the selected protocol (AnaLink: 128 bytes, multiplex: 224 bytes), but they are always located from byte-address 10<sub>h</sub> and upwards. The AnaLink values are represented as simple 8-bit values with 0 corresponding to the lowest value and FF<sub>h</sub> corresponding to the highest value. The multiplex values are represented as 16-bit "sign and magnitude"-values. The most significant bit defines the sign (0:+, 1:-) while the remaining 15 bits defines the magnitude (0..32768).

The second and third table below define how to read the analog Dupline values on PROFIBUS-DP when respectively AnaLink or multiplex protocol is selected.

### Byte 0.. 0F<sub>h</sub> Digital input data

Byte address	Dupline Group	Bit	Channel Number
0	A	7	A1
1	B	6	B2
2	C	5	C3
3	D	4	D4
4	E	3	E5
•	•	•	•
•	•	•	•
D	N	2	N6
E	O	1	O7
F	P	0	P8

### Byte 10.. 8F<sub>h</sub> Analog input data, AnaLink selected

Byte address	Channel Numbers
10.. 17	A1.. A8
18.. 1F	B1.. B8
20.. 27	C1.. C8
28.. 2F	D1.. D8
30.. 37	E1.. E8
•	•
•	•
78.. 7F	N1.. N8
80.. 87	O1.. O8
88.. 8F	P1.. P8

### Byte 10.. EF<sub>h</sub> Analog input data, multiplex selected

Byte address	Channel Numbers	Multiplex address
10.. 11	C.. D	0
12.. 13	C.. D	1
•	•	•
2C.. 2D	C.. D	E
2E.. 2F	C.. D	F
30.. 31	E.. F	0
•	•	•
4E.. 4F	E.. F	F
•	•	•
EE.. EF	O.. P	F



## Mode of Operation (cont.)

### Dupline output data

The digital outputs of the Dupline channels can be controlled through 16 PROFIBUS-DP output-bytes. In the table below, it is defined how to control the digital status of the individual Dupline channels.

### Byte 0.. F<sub>h</sub> Digital output data

Byte address	Dupline Group	Bit	Channel Number
0	A	7	A1
1	B	6	B2
2	C	5	C3
3	D	4	D4
4	E	3	E5
•	•	•	•
•	•	•	•
D	N	2	N6
E	O	1	O7
F	P	0	P8

## Switch Settings

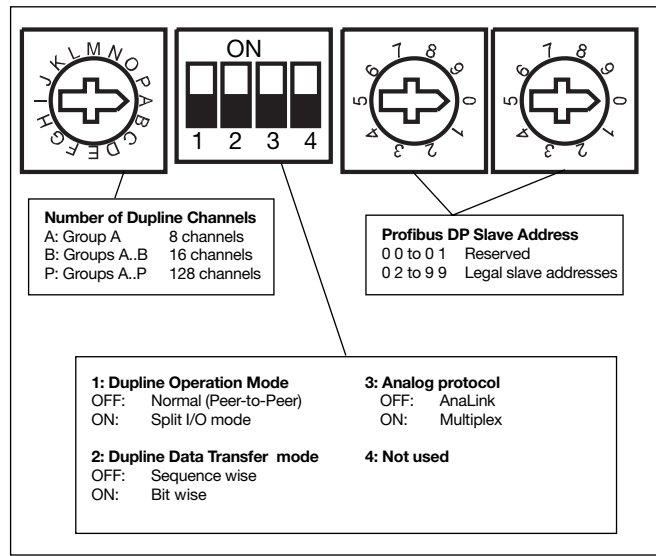

## Pin Assignment

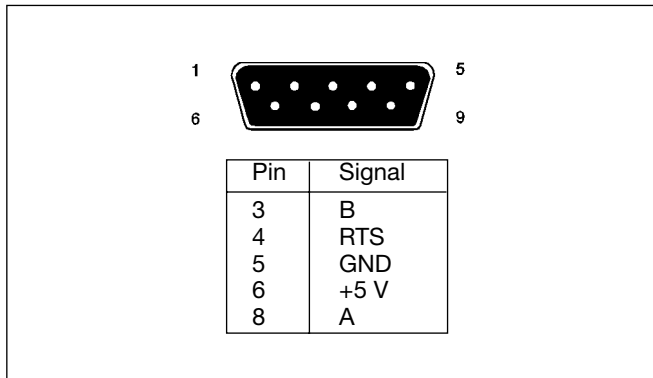

## Dimensions (mm)

D-housing

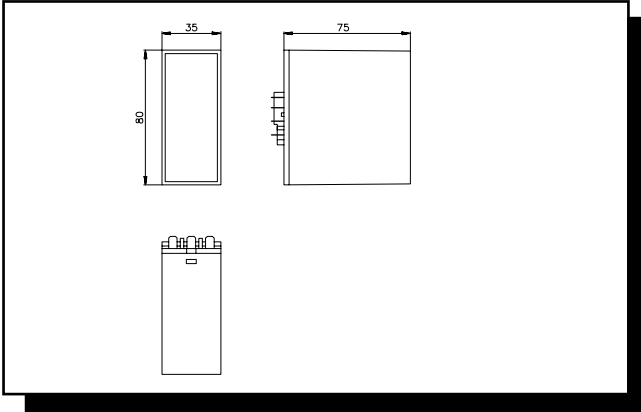

H1/H2-housing

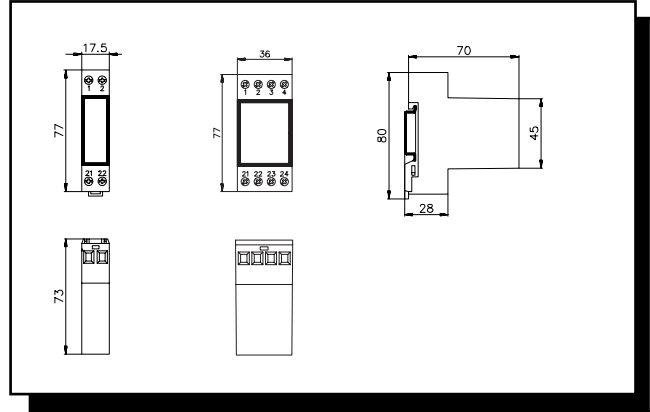

H4-housing

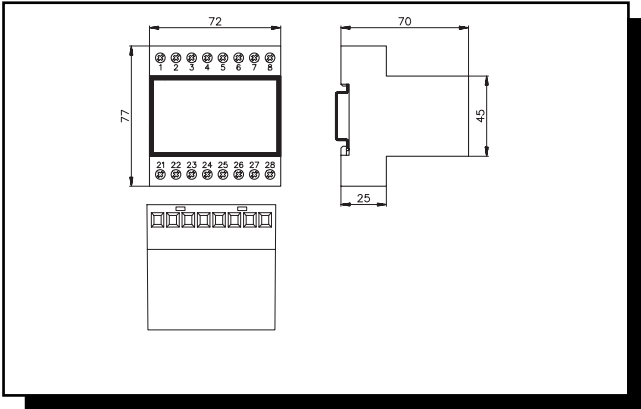

H8-housing

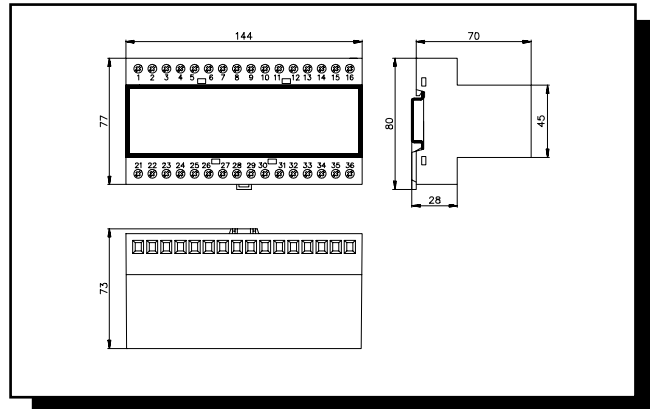

96 x 48-housing

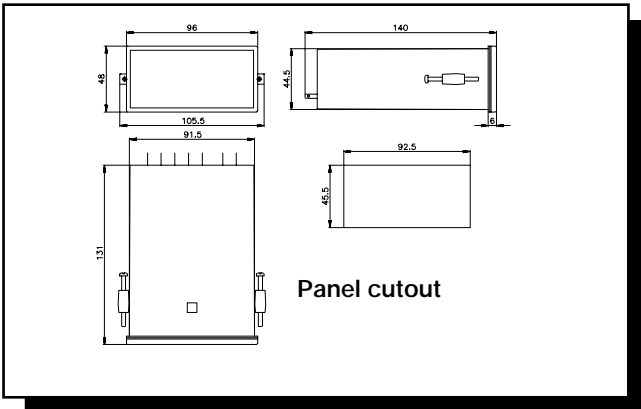

144 x 48-housing

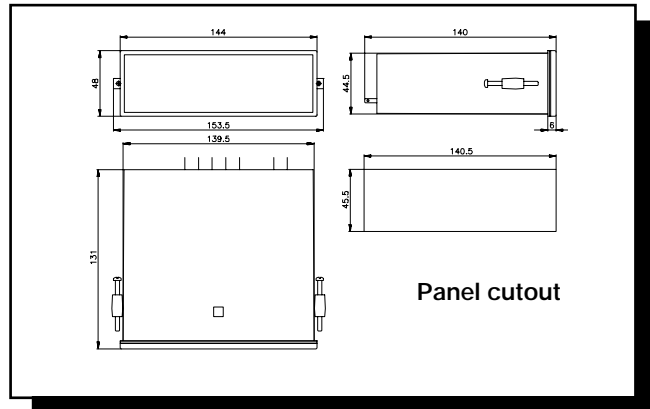

Mini-E Housing

