

CA12KAN08BPxxIO - IO-Link



Capacitive Proximity Sensors with IO-Link communication



Benefits

- **A complete family.** Available in M12 in a robust PEEK/ PBT housing with an operation of 0.5-8 mm non-flush.
- **Enhanced EMC performance:** 4th Generation TRIPLESIELD™
- **Easy customization to specific OEM requests:** different cable lengths and materials, special labelling: customized pig-tail solutions with special cables and connectors are possible on request..
- **The output** can be operated either as a switching output or in IO-Link mode.
- **Fully configurable via output IO-Link v 1.1.** Electrical outputs can be configured as PNP / NPN / Push-Pull / External input, normally open or normally closed.
- **Timer functions** can be set, such as ON-delay, Off-delay, and one shot.
- **Logging functions:** Temperature, detecting counter, power cycle and operating hours.
- **Detection modes** Single point, two point and windows mode.
- **Analogue output:** In IO-Link mode the sensor will generate 16 bit analogue process data output representing the dielectric value measured by the sensor.

Description

The new generation of CA12KA...IO sensors are a complete family of high performance capacitive sensors for detection of most solid or liquid targets in industrial applications such as Plastic & Rubber, Agriculture, Food & Beverage and Materials handling. The 4th Generation of TRIPLESIELD™ technology provides increased immunity to electromagnetic interference (EMI), especially to frequency drives, and improves immunity to humidity and dust.

On-board IO-Link communication opens up a variety of functions, such as easy communication and customization of advanced parameter settings.



Applications

- Detection presence of ink level in large ink jet printers for e.g., tile production.



Main functions

- The sensor can be operated in IO-Link mode once connected to an IO-Link master or in standard I/O mode.

Adjustable parameters via IO-Link interface:

- Sensing distance and hysteresis.
- Sensing modes: single point or two point or window mode.
- Timer functions, e.g.: On-delay, Off delay, One shot leading edge or trailing edge.
- Logic functions such as: AND, OR, X-OR and SR-FF.
- External input.
- Logging functions: Maximum temperatures, minimum temperatures, operating hours, operating cycles, power cycles, minutes above maximum temperature, minutes below minimum temperature, etc.

References

Product selection key

 CA12KAN08BP IO

 Enter the code option instead of

Code	Option	Description
C	-	Sensing principle: Capacitive sensor
A	-	Cylindrical housing with threaded barrel
12	-	Housing diameter (mm)
K	-	PEEK + PBT housing
A	-	Axial sensing
N	-	Non-flush installation
08	-	Sensing distance: 8 mm
B	-	Selectable functions: NPN, PNP, Push-Pull, External Input (only pin 2) or External teach input (only pin 2)
P	-	Selectable: N.O. or N.C., each output
<input type="checkbox"/>	A2	2 metre PVC cable
	M1	M12, 4-pole connector
IO	-	IO-Link version

Additional characters can be used for customized versions.

Type selection

Connection	Distance	Mounting	Code
Cable	8 mm	Non-flush	CA12KAN08BPA2IO
Plug	8 mm	Non-flush	CA12KAN08BPM1IO

Structure

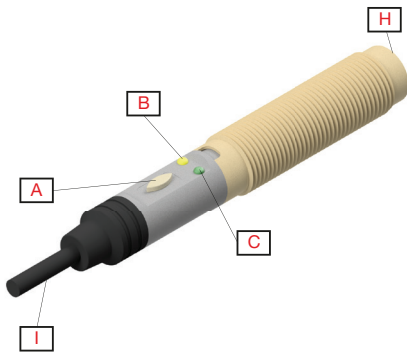

Fig. 1 Cable

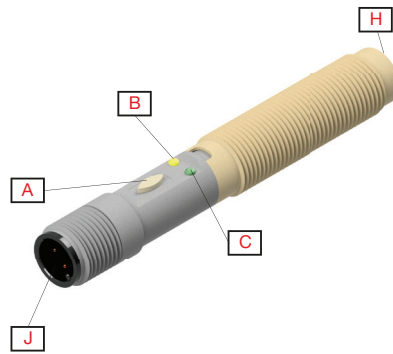

Fig. 2 Plug

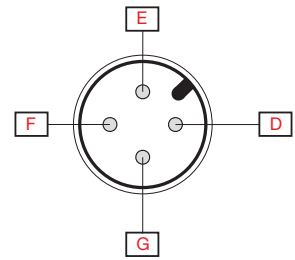
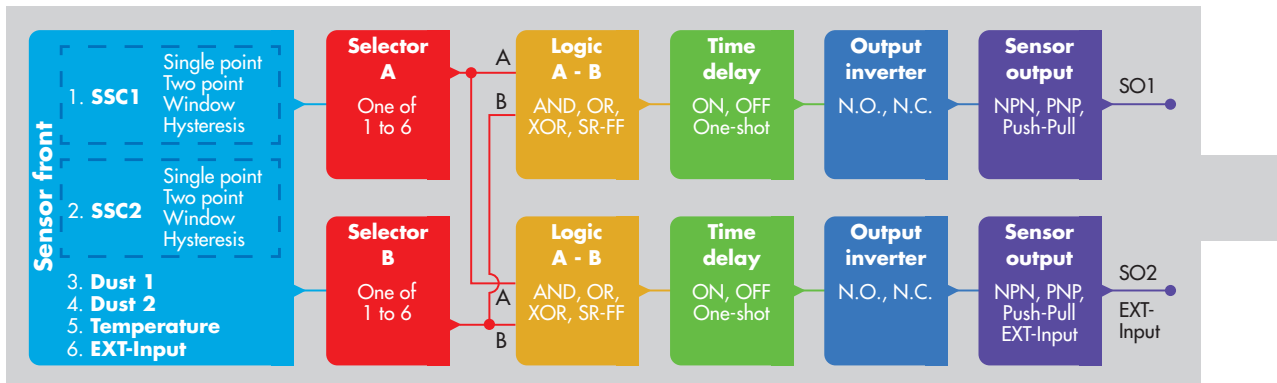

Fig. 3 Colour code

A	Teach-button	F	Blue (Pin 3)
B	Yellow LED	G	Black (Pin 4)
C	Green LED	H	Sensing face
D	Brown (Pin 1)	I	2 m, 4 wire PVC Ø 3.3 mm cable
E	White (Pin 2)	J	M12x1, 4-pin male connector

Sensing

Detection



Switching mode	SSC1 <ul style="list-style-type: none"> • Deactivated • Single point mode • Two point mode • Windows mode Factory settings: <i>Single point mode</i>	SSC2 <ul style="list-style-type: none"> • Deactivated • Single point mode • Two point mode • Windows mode Factory settings: <i>Single point mode</i>
Rated operating distance (S_n)	0 ... 8 mm (Factory settings: 8 mm), (ref. target 24x24 mm ST37, 1 mm thick, grounded)	
Sensitivity control	Adjustable by Teach-button, external teach or by IO-Link settings <ul style="list-style-type: none"> • Teach-button disabled • Teach-button enabled • Teach by wire Factory settings: <i>Teach-button enabled</i>	
Teach-button	Used for teaching background or target	
Adjustable distance	0.5 ... 8 mm Factory settings: <i>SP1 1000 and SP2 10000</i>	
Effective operating distance (S_r)	$0.9 \times S_n \leq S_r \leq 1.1 \times S_n$	
Usable operating dist. (S_u)	$0.8 \times S_r \leq S_u \leq 1.2 \times S_r$	
Hysteresis (H)	Adjustable by IO-Link (1% to 100%) Factory settings: <i>Typical 6%</i>	
Filter scaler	This function can increase the immunity towards unstable targets and electromagnetic disturbances: Value can be set from 1 to 255. Factory settings: <i>1</i> (1 is max. operating frequency and 255 is min. operating frequency)	

Alarm settings

Dust alarm SSC1 and SSC2	0 to 100 % of actual SP Factory settings: <i>Safe limits 12%</i>
Temperature alarm	<ul style="list-style-type: none"> • High threshold -50 to +125°C • Low threshold -50 to +125°C Factory settings: <i>High value 85°C (front temperature sensor used)</i> <i>Low value -30°C (front temperature sensor used)</i>

Detection diagram

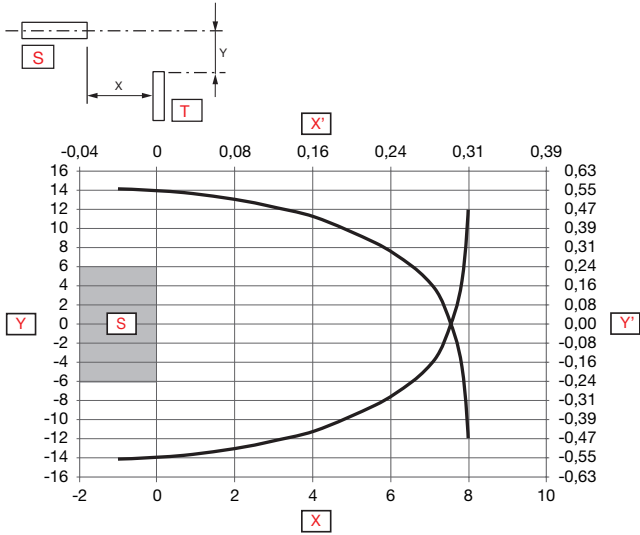

Y	Detection width [mm]	X'	Sensing range [inches]
X	Sensing range [mm]	S	Sensor
Y'	Detection width [inches]	T	Target

Accuracy

Repeat accuracy (R)	≤ 5%
----------------------------	------



Operation diagram

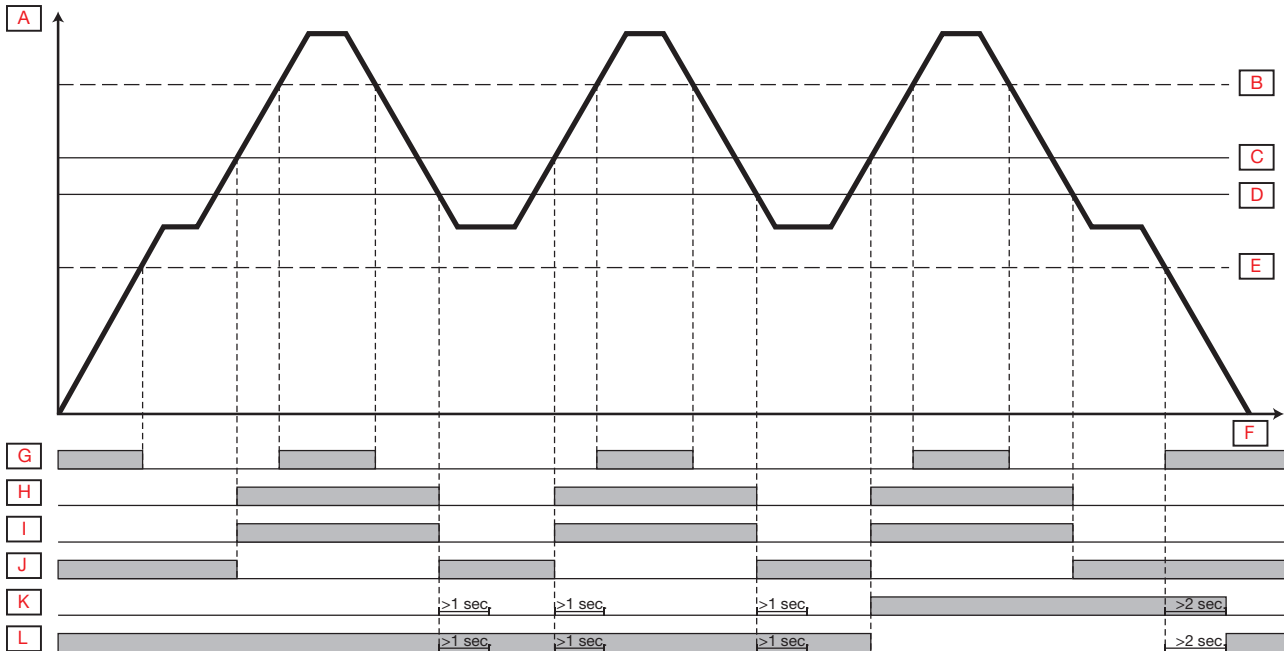

A	Target influence	G	Green LED ON
B	stable ON	H	Yellow LED ON
C	Output ON	I	Output N.O.
D	Output OFF	J	Output N.C.
E	stable OFF	K	Dust alarm N.O.
F	Time	L	Dust alarm N.C.

For default factory sensor

Tv = Power-ON delay

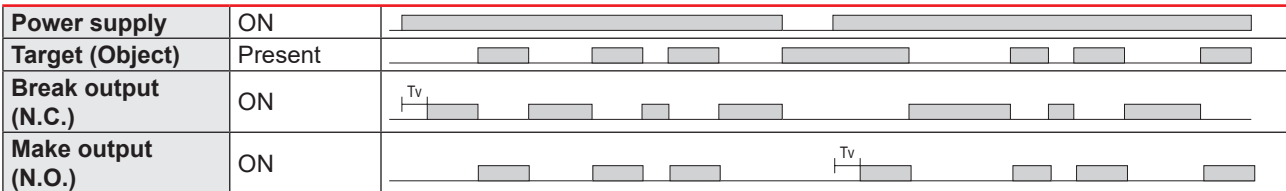

Features

Power Supply

Rated operational voltage (U_B)	10 ... 40 VDC (ripple included)
Ripple (U_{rpp})	$\leq 10\%$
No load supply current (I_o)	≤ 20 mA
Rated insulation voltage (U_i)	50 VDC
Power-ON delay (t_v)	≤ 300 ms

Input selector

Input selector	Channel A <ul style="list-style-type: none"> • Deactivated • SSC1 • SSC2 • Dust alarm 1 • Dust alarm 2 • Temperature alarm • External input Factory settings: SSC1	Channel B <ul style="list-style-type: none"> • Deactivated • SSC1 • SSC2 • Dust alarm 1 • Dust alarm 2 • Temperature alarm • External input Factory settings: SSC1
----------------	---	---

Logic functions

Logic functions	Channel A + B for SO1 <ul style="list-style-type: none"> • Direct • AND • OR • X-OR • SR-FF (Set-Reset Flip-Flop) Factory settings: Direct	Channel A + B for SO2 <ul style="list-style-type: none"> • Direct • AND • OR • X-OR • SR-FF (Set-Reset Flip-Flop) Factory settings: Direct
-----------------	---	---

Time delays

Timer mode	For SO1 <ul style="list-style-type: none"> • Disabled • ON delay • OFF delay • ON delay and OFF delay • One-shot leading edge • One-shot trailing edge Factory settings: Disabled	For SO2 <ul style="list-style-type: none"> • Disabled • ON delay • OFF delay • ON delay and OFF delay • One-shot leading edge • One-shot trailing edge Factory settings: Disabled
Timer scale	For SO1 <ul style="list-style-type: none"> • Milliseconds [ms] • Seconds [s] • Minutes [min] Factory settings: ms	For SO2 <ul style="list-style-type: none"> • Milliseconds [ms] • Seconds [s] • Minutes [min] Factory settings: ms
Timer value	For SO1 <ul style="list-style-type: none"> • 0 ... 32 767 Factory settings: 0	For SO2 <ul style="list-style-type: none"> • 0 ... 32 767 Factory settings: 0

Output Inverter

Output Inverter	For SO1 Pin 4 Black wire: <ul style="list-style-type: none"> • Not inverted [N.O.] • Inverted [N.C.] Factory settings: N.O.	For SO2 Pin 2 White wire: <ul style="list-style-type: none"> • Not inverted [N.O.] • Inverted [N.C.] Factory settings: N.C.
-----------------	---	---

Sensor Output

Switching Output Stage SO1 and SO2	For SO1 Pin 4 Black wire: <ul style="list-style-type: none"> • Disabled output • PNP • NPN • Push-Pull Factory settings: PNP	For SO2 Pin 2 White wire: <ul style="list-style-type: none"> • Disabled output • PNP • NPN • Push-Pull • External input, active high • External input, active low • Teach-in Factory settings: PNP
------------------------------------	--	---

Outputs

Rated operational current (I_o)	≤ 200 mA (Continuous, SO1 + SO2)	
OFF-state current (I_o)	≤ 100 μ A	
Minimum operational current (I_m)	$> 0,5$ mA	
Voltage drop (U_d)	≤ 1.0 VDC @ 200 mA DC	
Protection	Short circuit, reverse polarity, transients	
Utilization category	DC-12	Control of resistive loads and solid-state loads with optical isolation
	DC-13	Control of electromagnets
Load capacitance max at (U_o)	100 nF	

Response times

Standard mode		
Operating frequency (f)	15 Hz.	
Response times	CA12KAN...	t_{ON} (OFF-ON): < 26 ms
		t_{OFF} (ON-OFF): < 37 ms
High-speed mode		
Operating frequency (f)	50 Hz.	
Response times	CA12KAN...	t_{ON} (OFF-ON): < 9 ms
		t_{OFF} (ON-OFF): < 11 ms



Indication

Green LED	Yellow LED	Power	Function
In SIO and IO-Link mode			
ON	ON	ON	ON (stable)* SSC1
ON	OFF	ON	OFF (stable)* SSC1
OFF	ON	ON	ON (Not stable) SSC1
OFF	OFF	-	OFF (Not stable) SSC1
-	Flashing 10Hz 50% dutycycle	ON	Output short-circuit
-	Flashing (0.5...20Hz)	ON	Timer indication
In SIO mode only			
All teach procedures are starting with a flash ON 100 ms OFF until teach-window start			
Flashing 1 short pulse simultaneously on both LED's		ON	External teach by wire. Only for single point mode
Flashing 1 short pulse per sec simultaneously on both LED's		ON	Teach background (3 - 6 sec)
Flashing 2 short pulses per sec simultaneously on both LED's		ON	Teach target (6 - 9 sec)
Flashing 3 short pulses per sec simultaneously on both LED's		ON	Cancel teach procedure (> 9 sec)
Flashing 4 times simultaneously, 50% dutycycle		ON	Teach successful
In IO-Link mode only			
Flashing 1 HZ In stable mode: ON 900 ms OFF 100 ms In non stable mode: ON 100 ms OFF 900 ms	-	ON	Sensor is in IO-Link mode
Flashing 2 Hz alternating 50% dutycycle		ON	Find my sensor

*See operation diagram

LED indication

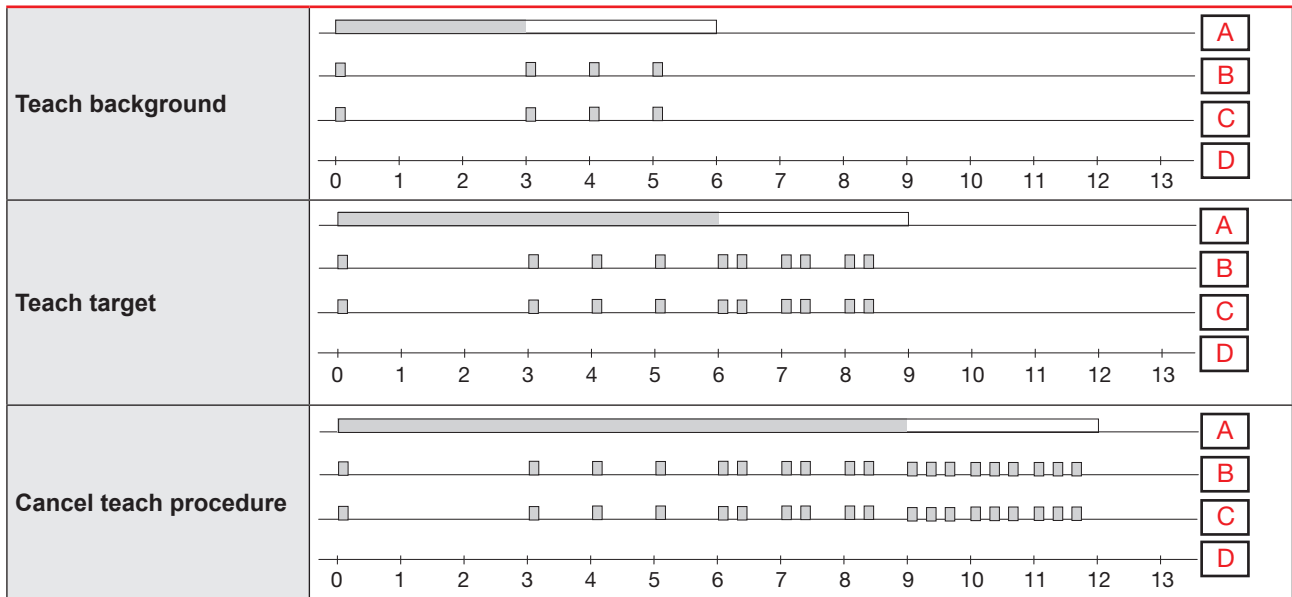
IO-Link LED indication modes	<ul style="list-style-type: none"> • LED Indication disabled • LED Indication enabled • Find my sensor <p>Factory settings: LED Indication enabled</p>
-------------------------------------	--



A	Teach-button	D	Time (sec)
B	Green LED	<input type="checkbox"/>	Active
C	Yellow LED		

Environmental

Ambient temperature	-30°C... +85°C (-22°F... +185°F)	Operating
	-40°C ... +85°C (-40°F ... +185°F)	Storage
Ambient humidity range	35% ... 95%	Operating
	35% ... 95%	Storage
Vibration	10 ... 150 Hz, 1 mm / 15 G	EN 60068-2-6
Shock	30 G / 11 ms, 3 pos, 3 neg per axis	EN 60068-2-27
Drop test	2 x 1 m 100 x 0.5 m	EN 60068-2-31
Rated insulation voltage	50VDC	
Rated impulse withstand voltage	> 2kV (with 500 Ω)	
Overvoltage category	III	IEC 60664, EN 60947-1
Pollution degree	3	IEC 60664, 60664A; EN 60947-1
IP rating	IP 67, IP 68/60 min.,	EN 60529, EN 60947-1
NEMA Enclosure Types	1, 2, 12	NEMA 250
Tightening torque	≤ 1.8 Nm	
Dielectric insulation voltage	1kVAC rms (50/60 Hz for 1 min.)	



Exceeding the norms for capacitive sensors.

Electrostatic discharge immunity test	contact discharge	> 30 kV	IEC 61000-4-2; EN60947-1
	air discharge	> 30 kV	
Electromagnetic field immunity	15 V/m		IEC 61000-4-3; EN60947-1
Electrical fast transient immunity	±4kV / 5kHz		IEC 61000-4-4; EN60947-1
Wire-conducted noise	> 10 Vrms		IEC 61000-4-6; EN60947-1
Power frequency magnetic fields	Continuous	> 60 A/m, 75.9 μ tesla	IEC 61000-4-8; EN60947-1
	Short-time	> 600 A/m, 759 μ tesla	



Function	Unit	Range
Values stored in the sensor (Saved every hour)		
Operating Hours	[h]	0 ... 2 147 483 647
Number of Power Cycles	[cycles]	0 ... 2 147 483 647
Maximum temperature - All time high	[°C]	-50 ... +150
Minimum temperature - All time low	[°C]	-50 ... +150
Detection counter SSC1	[cycles]	0 ... 2 147 483 647
Minutes above Maximum Temperature	[min]	0 ... 2 147 483 647
Minutes below Minimum Temperature	[min]	0 ... 2 147 483 647
Values stored in the sensor (Saved with events)		
Error Count	[counts]	0 ... 2 147 483 647
Download counter	[counts]	0 ... 65 536
Quality of Teach	[%]	0 ... 250%
Values not saved in sensor		
Maximum temperature - Since last power-up	[°C]	-50 ... +150
Minimum temperature - Since last power-up	[°C]	-50 ... +150
Current temperature	[°C]	-50 ... +150
Quality of Run	[%]	0 ... 250%



Events	Factory default setting
Temperature fault event	Inactive
Temperature over-run	Inactive
Temperature under-run	Inactive
Short circuit	Inactive
Maintenance	Inactive

 Process data configuration

Process Data	Factory default setting
Analogue value	Active
SC, Short circuit	Inactive
TA, Temperature alarm	Inactive
DA2, Dust alarm for SSC2	Inactive
DA1, Dust Alarm for SSC1	Inactive
SSC2, Sensor switching channel 2	Inactive
SSC1, Sensor switching channel 1	Inactive
SO2, Switching output 2	Active
SO1, Switching output 1	Active

Process data structure

4 Bytes, Analogue value 16 ... 31 (16 bit)

Byte 0	31	30	29	28	27	26	25	24
	MSB	-	-	-	-	-	-	-
Byte 1	23	22	21	20	19	18	17	16
	-	-	-	-	-	-	-	LSB
Byte 2	15	14	13	12	11	10	9	8
	-	-	SC	TA	DA2	DA1	SSC2	SSC1
Byte 3	7	6	5	4	3	2	1	0
	-	-	-	-	-	-	SO2	SO1

Mechanics/electronics

Connection

Cable	2 m, 4 wire, 4 x 0.14 mm ² , Ø3.3 mm Oil proof PVC, black
Plug (M1)	M12 x 1, 4 pin male

Wiring

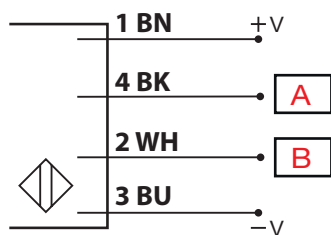

BN	BK	WH	BU	A	B
Brown	Black	White	Blue	OUT/IO-Link	IN/OUT

Housing

Body front	PEEK Beige	
Body back	PBT Grey	
Teach-button	TPE	
Light guides	TPE	
Cable gland	Polyester, softened	
Finger nuts	PBT Black, 30% glass-reinforced	
Dimensions	M12 x 1	Thread
Thread length	36 mm	
Total length	78 mm	Cable version
	80 mm	Plug version
Weight	30 g	Cable version
	20 g	Plug version

Dimensions (mm)

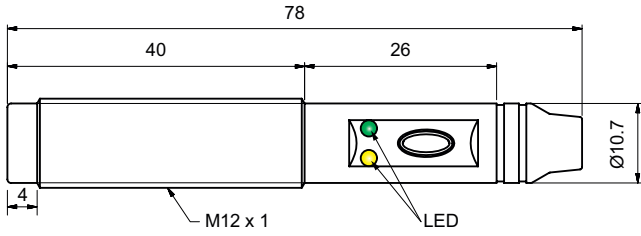

Fig. 4 Cable

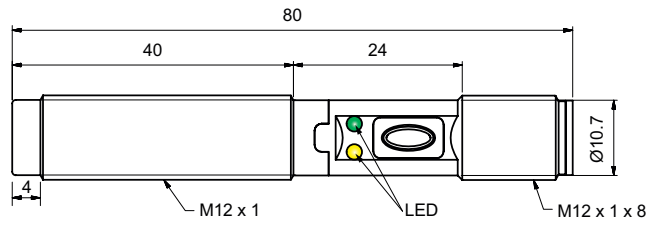



Fig. 5 Plug

Compatibility and conformity

Approvals and markings

General reference	Sensor designed according to EN60947-5-2 and EN60947-1	
MTTF_d	161.1 years @ 40°C (+104°F)	ISO 13849-1, SN 29500
CE-marking		
Approvals	 (UL508)	

IO-Link

IO-Link revision	1.1
Transmission rate	COM2 (38.4 kbaud)
SDCI-Norm	IEC 61131-9
Profile	Smart sensor profile 2nd edition, common profile
Min. cycle time	5 ms
SIO mode	Yes
Min. master port class	A (4-pin)
Process data length	32 bit



Delivery contents and accessories



Delivery contents

Capacitive sensor: CA12KAN08BPxxIO
 2 x M12 finger nuts
 Packaging: Carton box

Accessories

Connector type CON.14NF-... -series.
 Mounting Brackets AMB12-S.. (straight), AMB12-A.. (angled)

Further information

Information	Where to find it	QR
IO-Link manual	http://cga.pub/?010b41	
Mounting brackets	http://cga.pub/?68adbc	
Connectors	http://cga.pub/?ae3678	



COPYRIGHT ©2024
 Content subject to change. Download the PDF: www.gavazziautomation.com